



# ROC286A

1U 19" Server with Intel Coffee Lake-R Processor User' Manual



**User's Manual**

Revision Date: May.28.2021

## Safety Information

### Electrical safety

- To prevent electrical shock hazard, disconnect the power cable from the electrical outlet before relocating the system.
- When adding or removing devices to or from the system, ensure that the power cables for the devices are unplugged before the signal cables are connected. If possible, disconnect all power cables from the existing system before you add a device.
- Before connecting or removing signal cables from the motherboard, ensure that all power cables are unplugged.
- Seek professional assistance before using an adapter or extension cord. These devices could interrupt the grounding circuit.
- Make sure that your power supply is set to the correct voltage in your area.
- If you are not sure about the voltage of the electrical outlet you are using, contact your local power company.
- If the power supply is broken, do not try to fix it by yourself. Contact a qualified service technician or your local distributor.

### Operation safety

- Before installing the motherboard and adding devices on it, carefully read all the manuals that came with the package.
- Before using the product, make sure all cables are correctly connected and the power cables are not damaged. If you detect any damage, contact your dealer immediately.
- To avoid short circuits, keep paper clips, screws, and staples away from connectors, slots, sockets and circuitry.
- Avoid dust, humidity, and temperature extremes. Do not place the product in any area where it may become wet.
- Place the product on a stable surface.
- If you encounter any technical problems with the product, contact your local distributor

### Statement

- All rights reserved. No part of this publication may be reproduced in any form or by any means, without prior written permission from the publisher.
- All trademarks are the properties of the respective owners.
- All product specifications are subject to change without prior notice

# ROC286A User's Manual

Revision Date:May.28.2021

## Revision History

Revision	Date (yyyy/mm/dd)	Changes
Version 1.0	2021/5/28	Initial release

## Packing list

- 19" 1U Rack-mount Intel® Q370 Fanless Rugged System
- Accessories

Item	Description	Q'ty
1	Driver CD	1
2	Bracket Ear	2
3	Screw for fixing Bracket Ear M4 L:7.8mm	6



If any of the above items is damaged or missing, please contact your local distributor.

## Ordering Information

### ROC286A-ET

19" 1U Rack-mount Rugged Fanless System with Intel® Coffee Lake-Refresh 8th/9th Processor(Up to 65W), 2 x DisplayPort, 1 x HDMI, 1 x PCIe x16, 6 x USB,9~36V DC-IN, Operating Temp. -20~+60°C

### ROC286A-UT

19" 1U Rack-mount Rugged Fanless System with Intel® Coffee Lake-Refresh 8th/9th Processor(Up to 65W), 2 x DisplayPort, 1 x HDMI, 1 x PCIe x16, 6 x USB,9~36V DC-IN, Operating Temp. -30~+70°C

## Table of contents

Safety Information .....	1
Electrical safety.....	1
Operation safety .....	1
Statement .....	1
Revision History.....	2
Packing list.....	2
Ordering Information .....	2
Chapter 1: Product Introduction .....	5
1-1 Key Features.....	5
1.2 Mechanical Dimensions .....	7
1.3 Panel Component.....	7
1.4 Rear Panel Component.....	8
Chapter 2: Jumpers and Connectors Locations .....	9
2.1 Rear Panel Connector Pin Definitions .....	9
Chapter 3 Getting Started .....	10
Chapter 4: AMI BIOS UTILITY.....	11
4.1 Starting.....	11
4.2 Navigation Keys.....	11
4.3 Main .....	12
4.4 Advanced .....	13
4.4.2 CPU Configuration .....	14
4.4.3 ACPI Setting .....	15
4.4.4 Smart Setting.....	15
4.4.5 F81866 Super IO Configuration .....	16
4.4.6 Hardware Monitor.....	17
4.4.7 Platform Function.....	18

# ROC286A User's Manual

Revision Date: May.28.2021

---

4.5 Chipset Menu.....	22
4.5.1 System Agent (SA) Configuration.....	23
4.5.2 PCH-IO Configuration .....	25
4.6 Security Menu.....	29
4.7 Boot Menu .....	30
4.8 Save & Exit .....	31

# ROC286A User's Manual

Revision Date: May.28.2021

## Chapter 1: Product Introduction

### 1-1 Key Features

#### SYSTEM

CPU	Socket LGA 1151 for Intel® Core i7/i5/i3/Celeron® (Supports up to 65W) Intel® 8th/9th Processor
-----	--

Memory type	2 x DDR4 SO DIMM up to 64 GB
-------------	------------------------------

Chipset	Intel® Q370 Chipset
---------	---------------------

Expansion Slot	1 x PCIe x16 ; 1x M.2 (Key M, 2242/2280) with PCIe x4 and SATA
----------------	--

#### STORAGE

HDD/SDD	2 x 2.5" SATA HDD/SSD easy swap tray
---------	--------------------------------------

#### ETHERNET

Ethernet	Intel® I210 & I219LM GbE LAN (support 10/100/1000 Mbps for x2 RJ45 ports)
----------	---

#### REAR I/O

Display Port	2 x DP
--------------	--------

HDMI	1 x HDMI
------	----------

Ethernet	2 x RJ45 Intel® I210 & I219LM GbE LAN (support 10/100/1000 Mbps)
----------	--

Audio	2 x 3.5mm Audio Jacks (1 x Mic-in, 1 x Line-out)
-------	--

COM	2 x RS232/422/485 ( 422 / 485 select by BIOS)
-----	---

USB Port	4 x USB 3.1(10Gb/s)
----------	---------------------

DC-IN	12V DC IN (1 x 4P x Terminal Block)
-------	-------------------------------------

#### FRONT I/O

Button	1 x Power Button w/Indicator LED
--------	----------------------------------

Indicator LED	HDD
---------------	-----

USB Port	2 x USB 2.0
----------	-------------

Easy Swap SSD Tray	2
--------------------	---

#### POWER REQUIREMENT

Power Input	9~36V DC IN
-------------	-------------

#### APPLICATIONS, OPERATING SYSTEM

Applications	Commercial and Industrial Platforms, Embedded Computing, Process
--------------	--



	Control Intelligent Automation and manufacturing applications
Operating System	Windows 10 64Bit Ubuntu13.04, Ubuntu13.10, Ubuntu14.04, Fedora 20
<b>PHYSICAL</b>	
Dimension (W x D x H)	482 x450 x 44.4 mm
Weight	8.92Kg
Chassis	SECC
Heatsink	Aluminum Alloy, Corrosion Resistant
Finish	Anodic aluminum oxide
<b>ENVIRONMENTAL</b>	
MIL-STD-810G Test	Method 507.5, Procedure II (Temperature & Humidity) Method 501.5, Procedure I (Storage/High Temperature) Method 501.5, Procedure II (Operation/High Temperature) Method 502.5, Procedure I (Storage/Low Temperature) Method 502.5, Procedure II (Operation/Low Temperature) Method 503.5, Procedure I (Temperature shock)
Green Product	RoHS compliance
Operating Temperature	w/o Graphic Card (ET: -20 to 60°C; UT: -30 to 70°C) ; w/Graphic Card (0 to 50°C)
Storage Temperature	-40 to 85°C
Relative Humidity	5% to 95%, non-condensing
EMC	CE and FCC compliance

## 1.2 Mechanical Dimensions

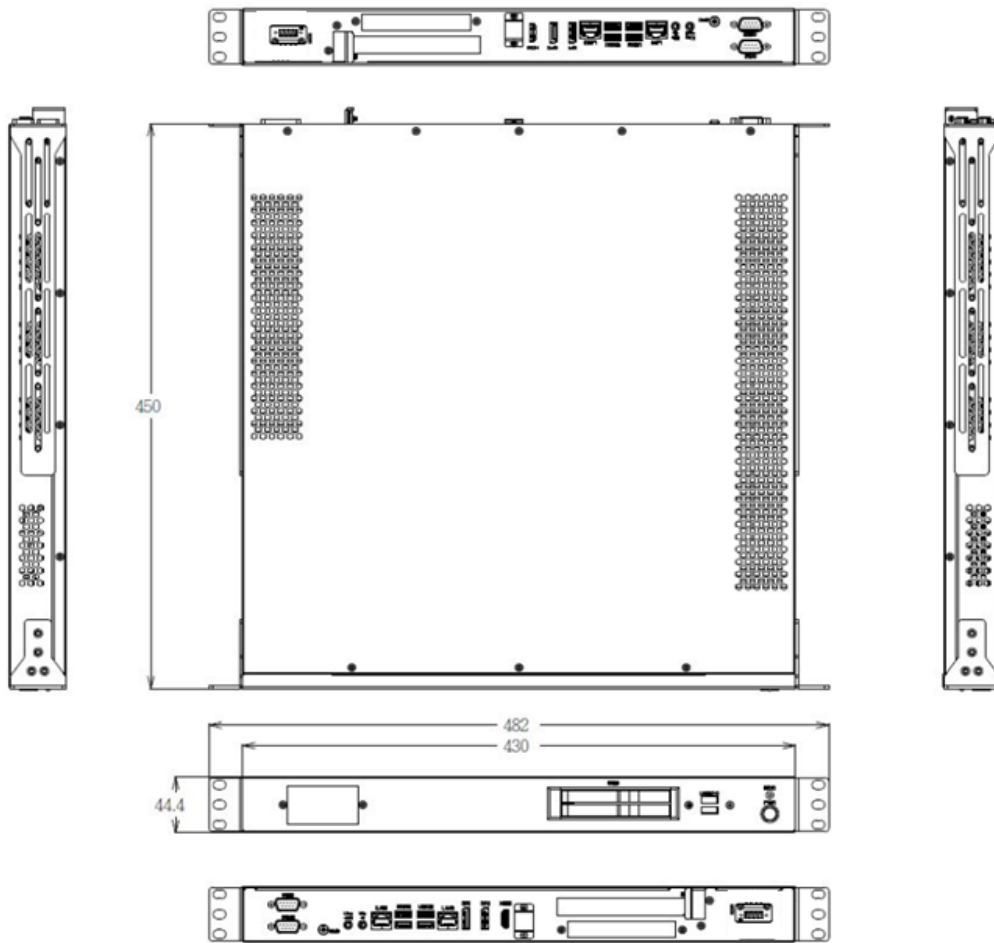

## 1.3 Panel Component

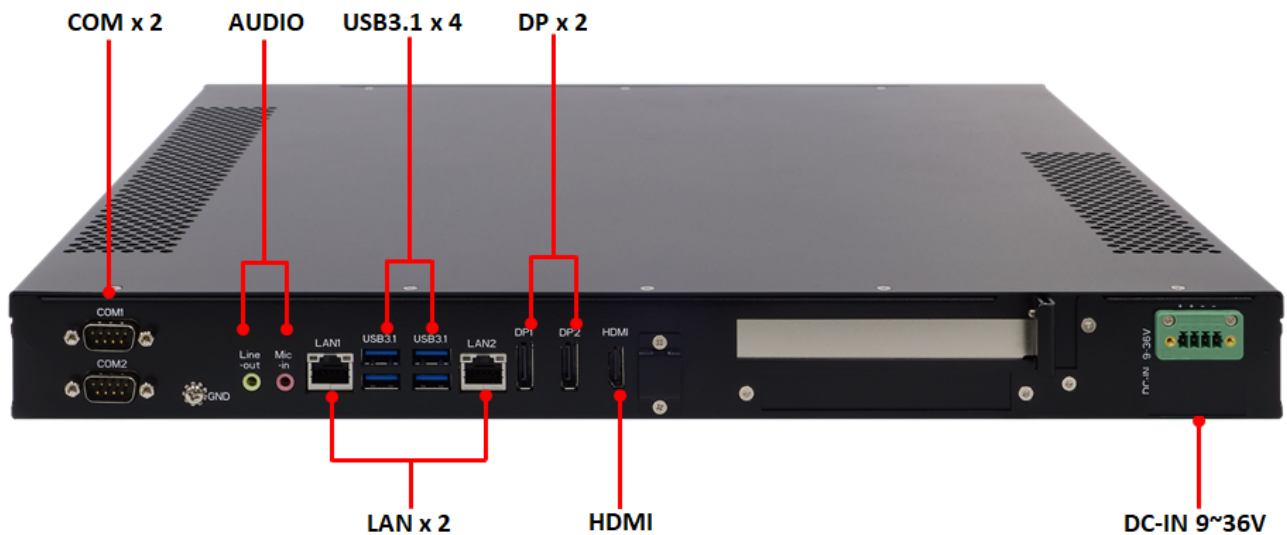



# ROC286A User's Manual

Revision Date: May.28.2021

---

## 1.4 Rear Panel Component



## Chapter 2: Jumpers and Connectors Locations

### 2.1 Rear Panel Connector Pin Definitions

#### LAN1 and LAN2 LED



##### LAN Port LED Indications

Activity/Link LED	
Status	Description
Off	No Link
Blinking	Data Activity
On	Link

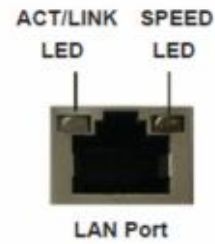
SPEED LED	
Status	Description
Off	10Mbps connection
Yellow	100Mbps connection
Green	1Gbps connection



#### AUDIO: LINE-OUT/MIC-IN

Pin	Definition	
1	Line-out	 Line-out
2	Mic-in	 Mic-in

#### COM 1 / 2 : RS232/422/485 (422 / 485 select by BIOS)

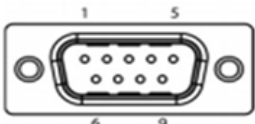
Pin	RS-232	
1	DCD-	
2	RXD	
3	TXD	
4	DTR-	
5	GND	
6	DSR-	
7	RTS-	
8	CTS-	
9	PWR (5V)	

## Chapter 3 Getting Started

This chapter provides more detailed information and let you know how to install components into the ROC286A fanless system.



Prior to removing the chassis cover, make sure the unit's power is off and disconnected from the power sources to prevent electric shock or system damage.

### 3.1 2.5" Easy Swap SSD installation

ROC286A support two 2.5" Easy Swap SSD

- Use Tri-angle security key to open keylock and pull out the 2.5"SSD tray.
- Put 2.5"SSD on the tray and make sure SSD is fixed and push the tray back.
- Use Tri-angle security key to lock tray door.

## Chapter 4: AMI BIOS UTILITY

This chapter provides users with detailed descriptions on how to set up a basic system configuration through the AMI BIOS setup utility.

### 4.1 Starting

To enter the setup screens, perform the following steps:

- Turn on the computer and press the <Del> key immediately.
- After the <Del> key is pressed, the main BIOS setup menu displays. Other setup screens can be accessed from the main BIOS setup menu, such as the Chipset and Power menus.

### 4.2 Navigation Keys

The BIOS setup/utility uses a key-based navigation system called hot keys. Most of the BIOS setup utility hot keys can be used at any time during the setup navigation process.

Some of the hot keys are <F1>, <F10>, <Enter>, <ESC>, and <Arrow> keys.



Some of the navigation keys may differ from one screen to another.

Left/Right	The Left and Right <Arrow> keys moves the cursor to select a menu.
Up/Down	The Up and Down <Arrow> keys moves the cursor to select a setup screen or sub-screen.
+– Plus/Minus	The Plus and Minus <Arrow> keys changes the field value of a particular setup setting.
Tab	The <Tab> key selects the setup fields.
F1	The <F1> key displays the General Help screen.
F10	The <F10> key saves any changes made and exits the BIOS setup utility.
Esc	The <Esc> key discards any changes made and exits the BIOS setup utility.
Enter	The <Enter> key displays a sub-screen or changes a selected or highlighted option in each menu.

## 4.3 Main

The Main menu is the first screen that you will see when you enter the BIOS Setup Utility.

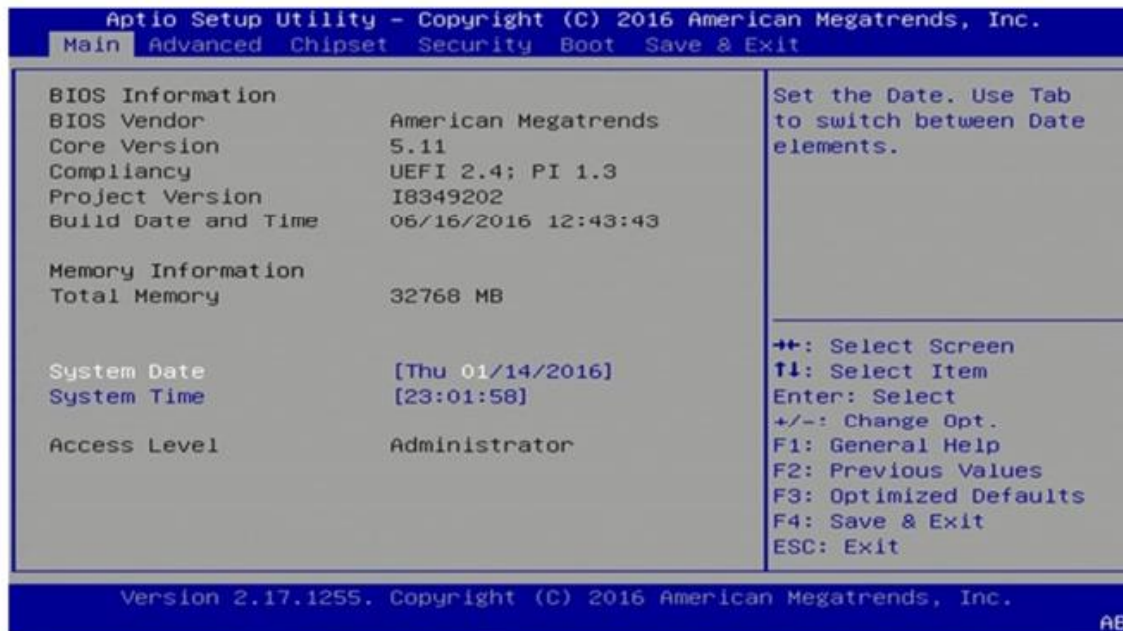

### System Date

Use this function to change the system date.

Select System Date using the Up and Down <Arrow> keys. Enter the new values through the keyboard. Press the Left and Right <Arrow> keys to move between fields.

The date setting must be entered in MM/DD/YY format.

### System Time

Use this function to change the system time.

Select System Time using the Up and Down <Arrow> keys. Enter the new values through the keyboard. Press the Left and Right <Arrow> keys to move between fields.

The time setting is entered in HH:MM:SS format.

**Note:** The time is in 24-hour format. For example, 5:30 A.M. appears as 05:30:00, and 5:30 P.M. as 17:30:00.

### Access Level

Display the access level of the current user in the BIOS.

## 4.4 Advanced

The Advanced Menu allows you to configure your system for basic operation. Some entries are defaults required by the system board, while others, if enabled, will improve the performance of your system or let you set some features according to your preference. **Setting incorrect field values may cause the system to malfunction.**

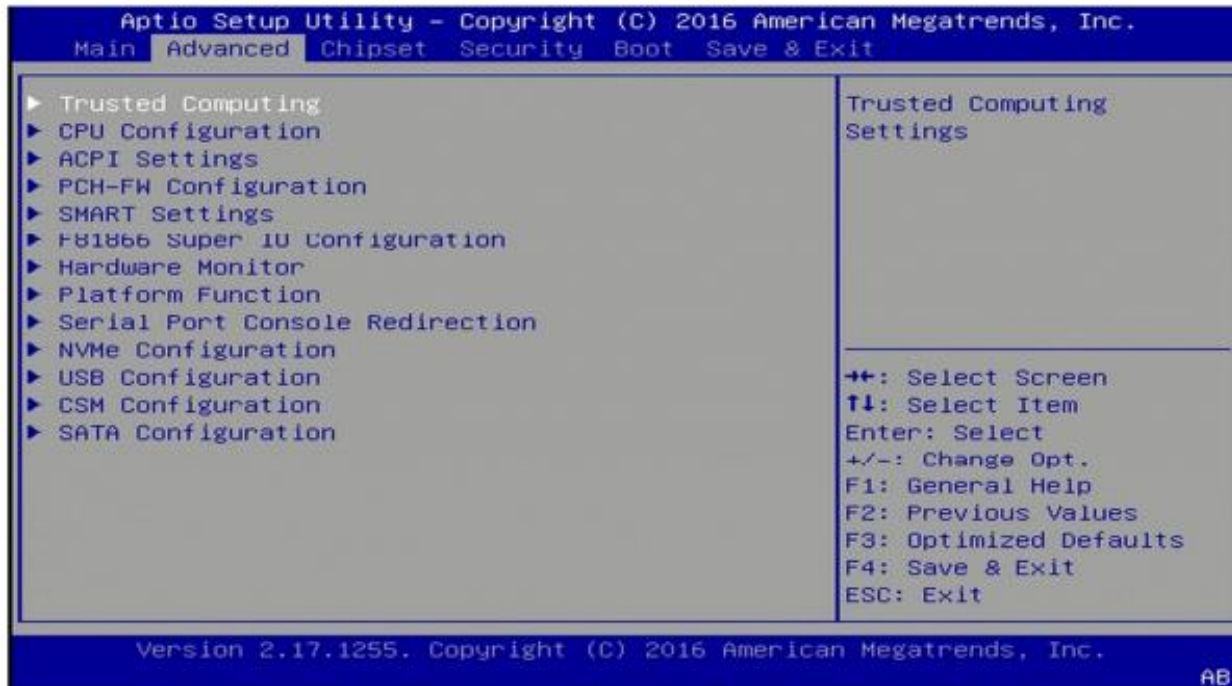

### 4.4.1 Trusted Computing

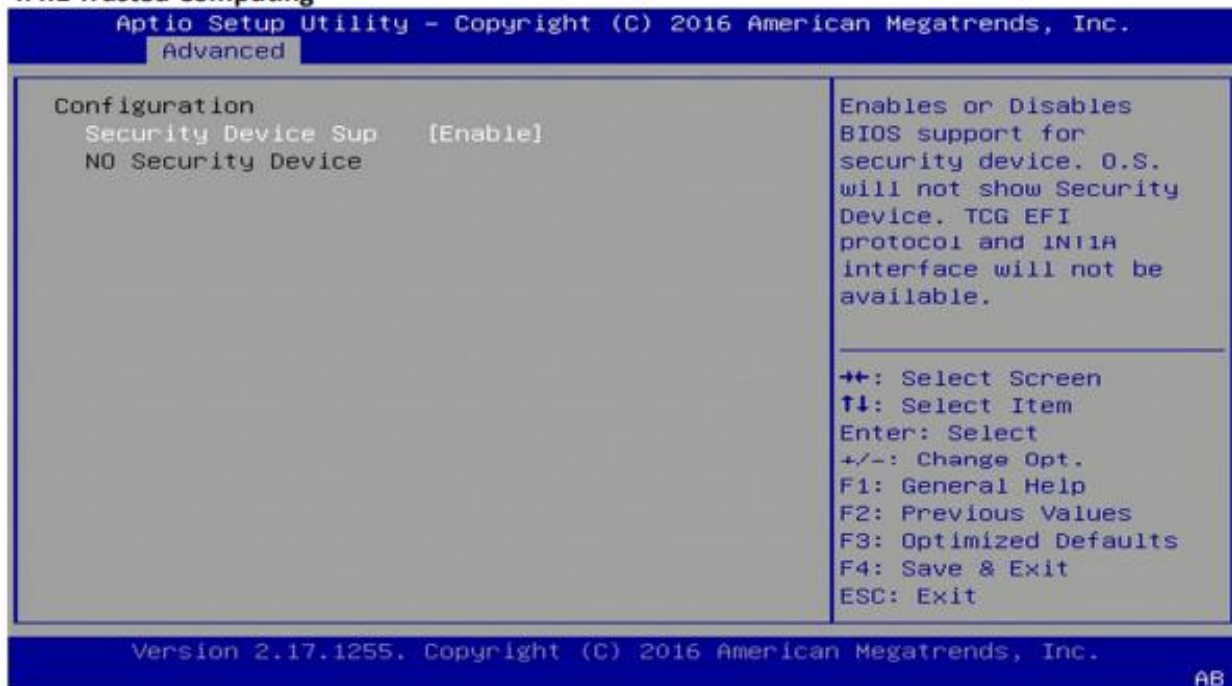

## 4.4.2 CPU Configuration

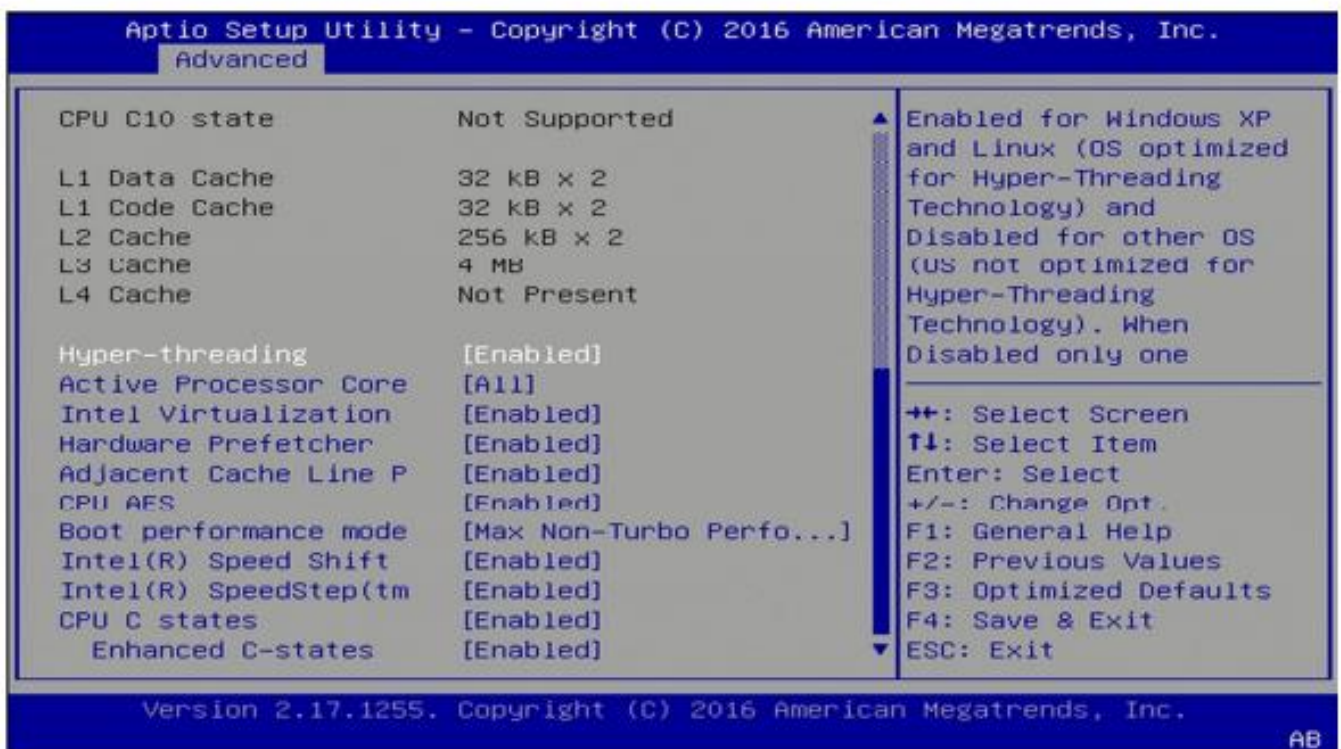
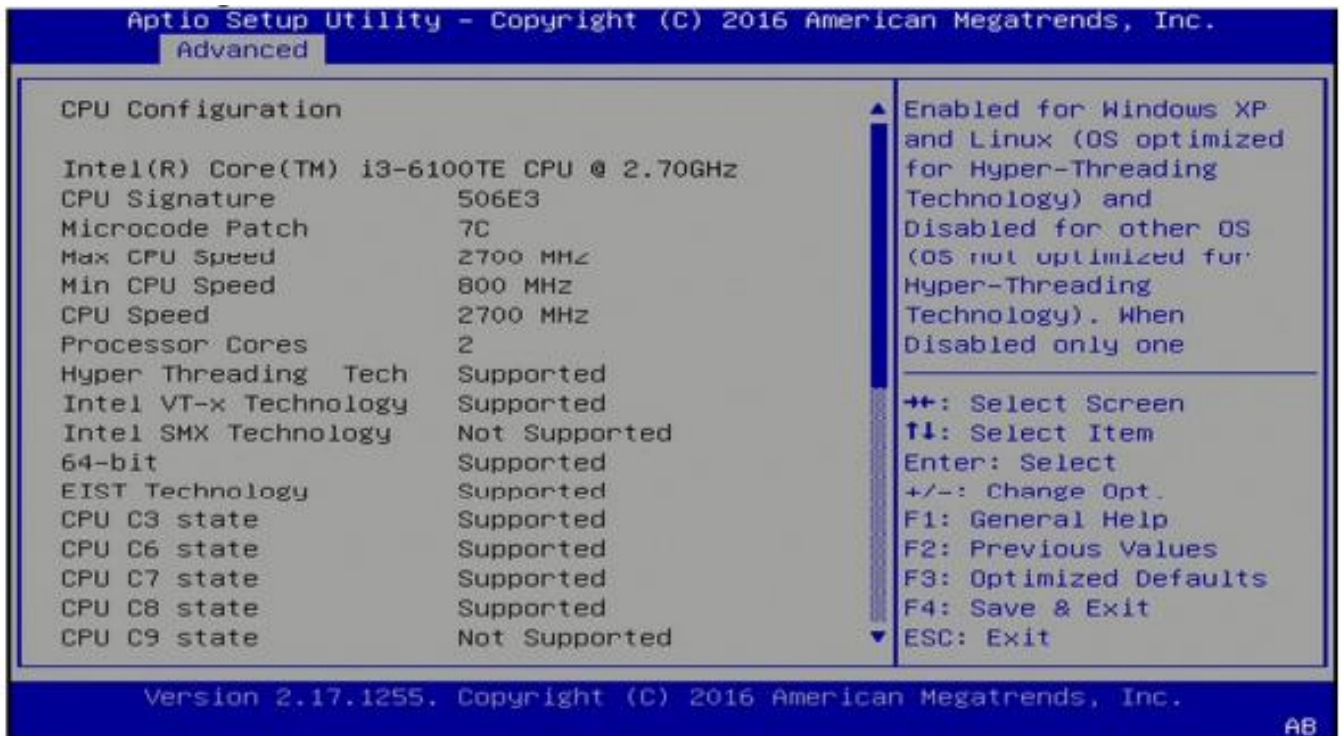

## 4.4.3 ACPI Setting



## 4.4.4 Smart Setting

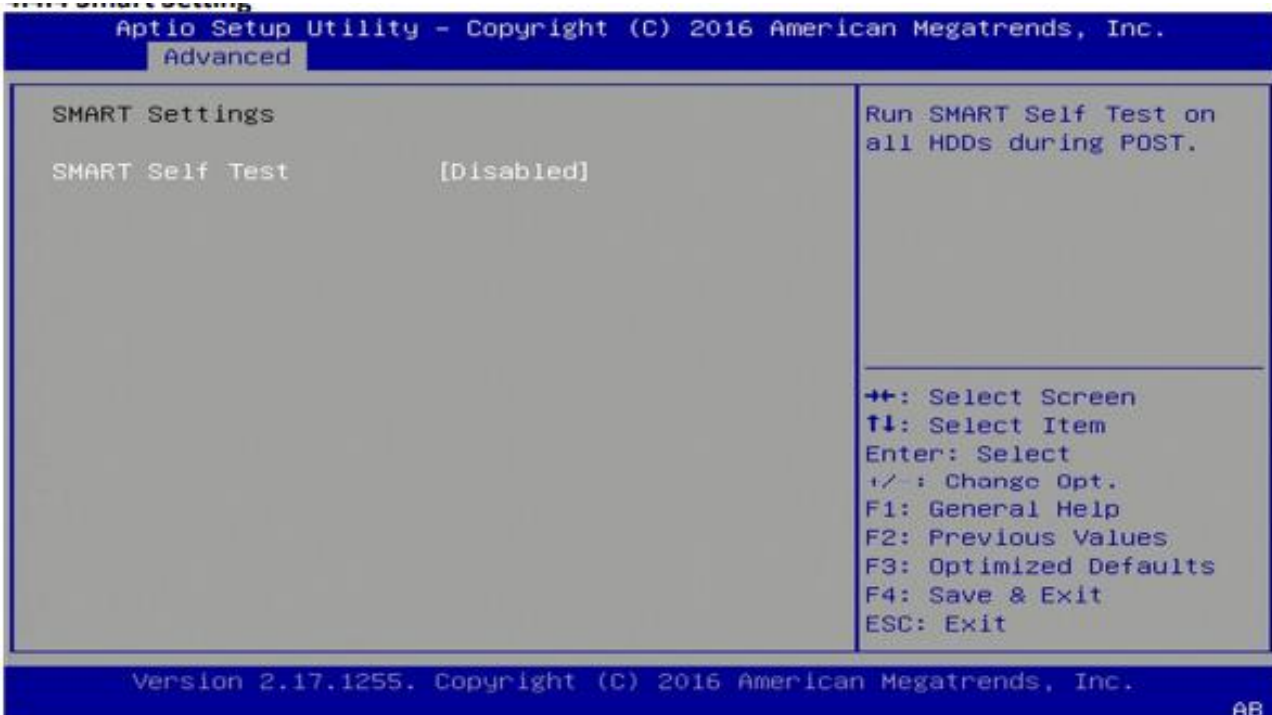



## 4.4.5 F81866 Super IO Configuration

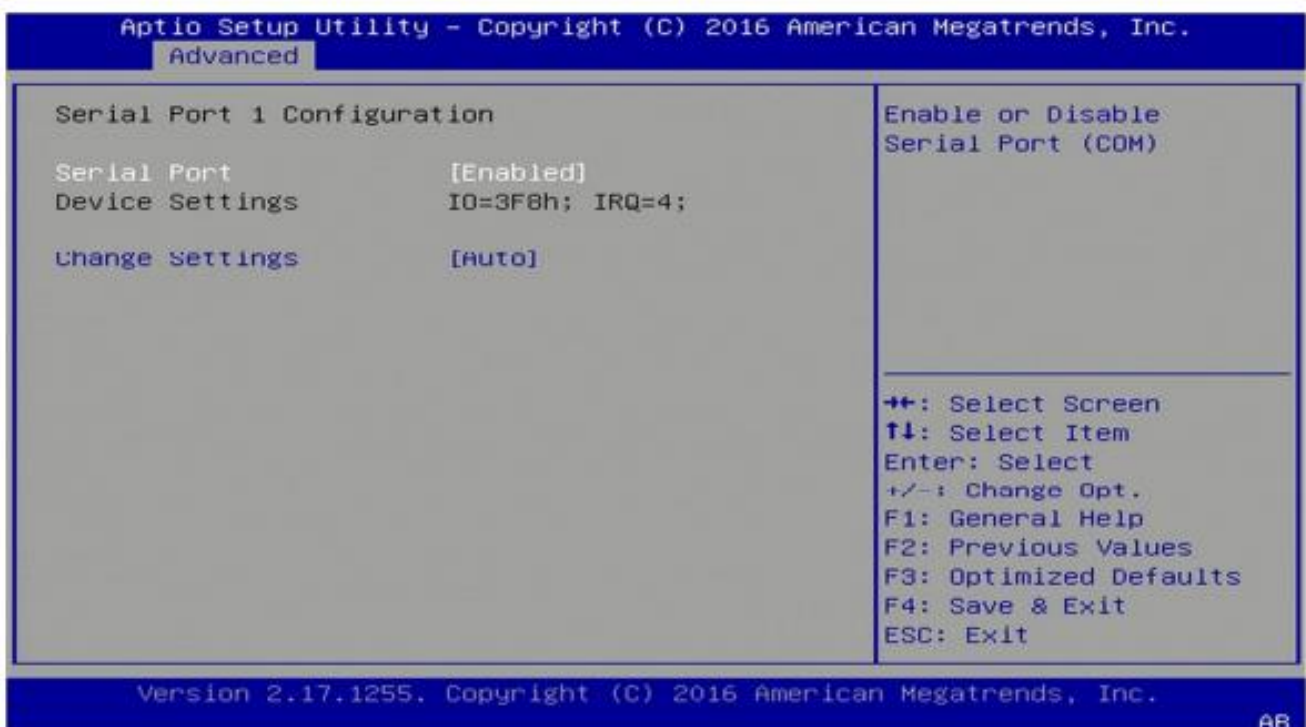
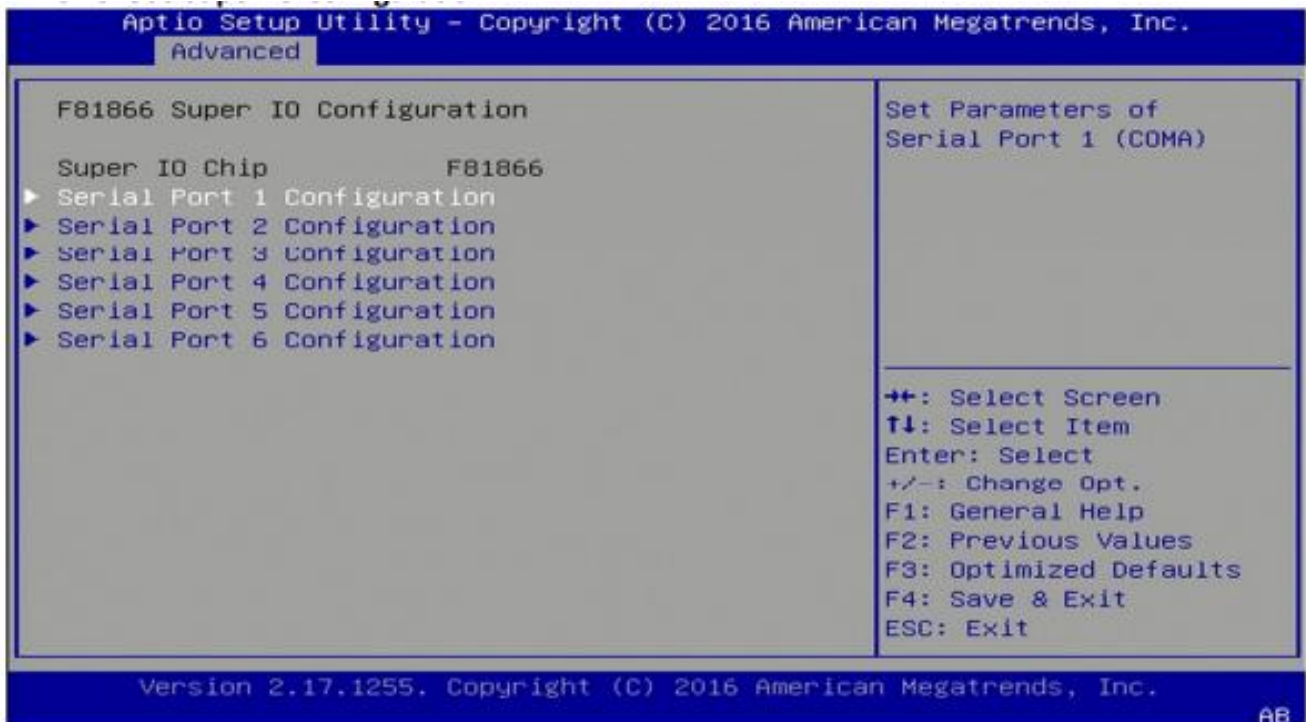

## 4.4.6 Hardware Monitor

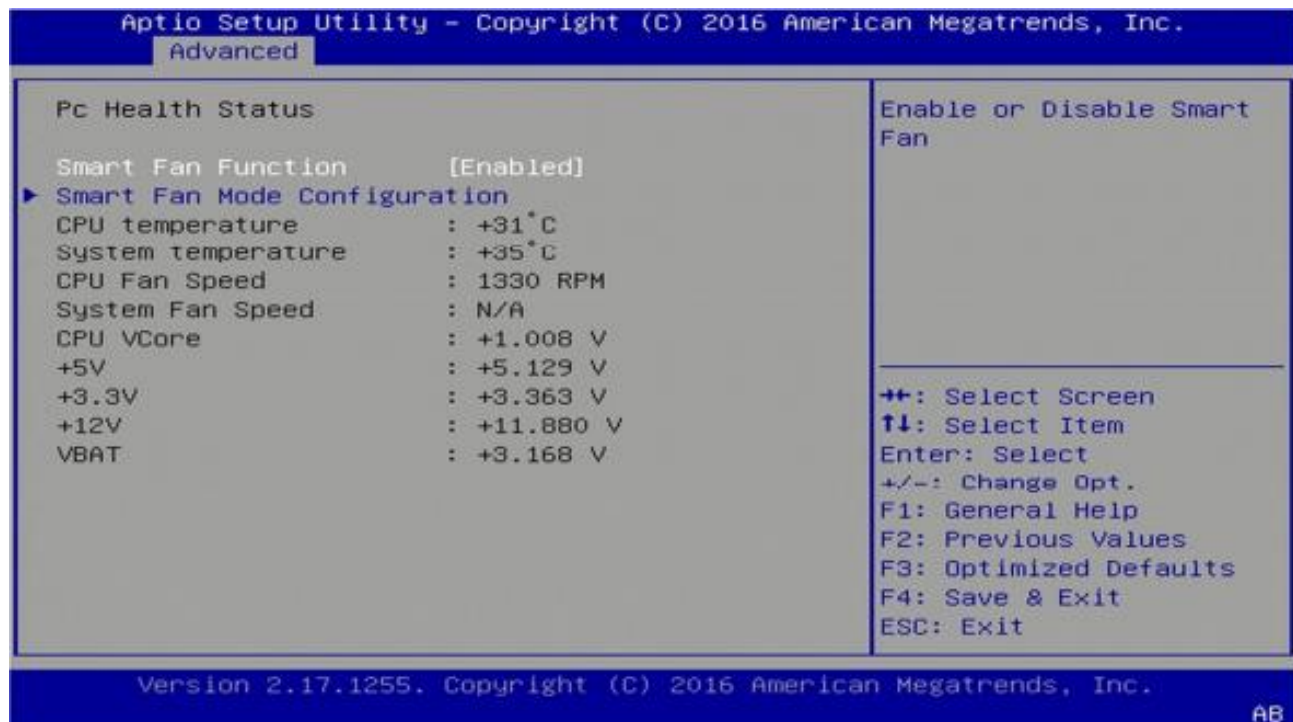

### 4.4.6.1 Smart Fan Mode Configuration

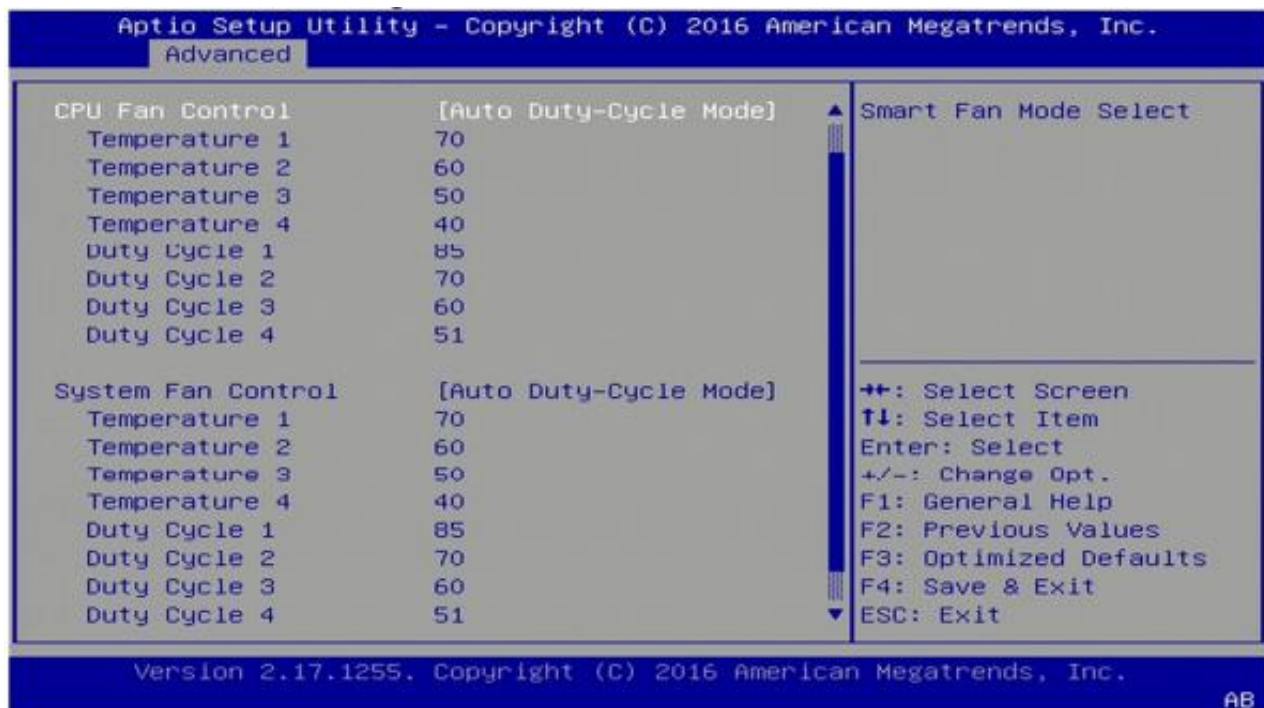

# ROC286A User's Manual

Revision Date: May.28.2021

## 4.4.7 Platform Function

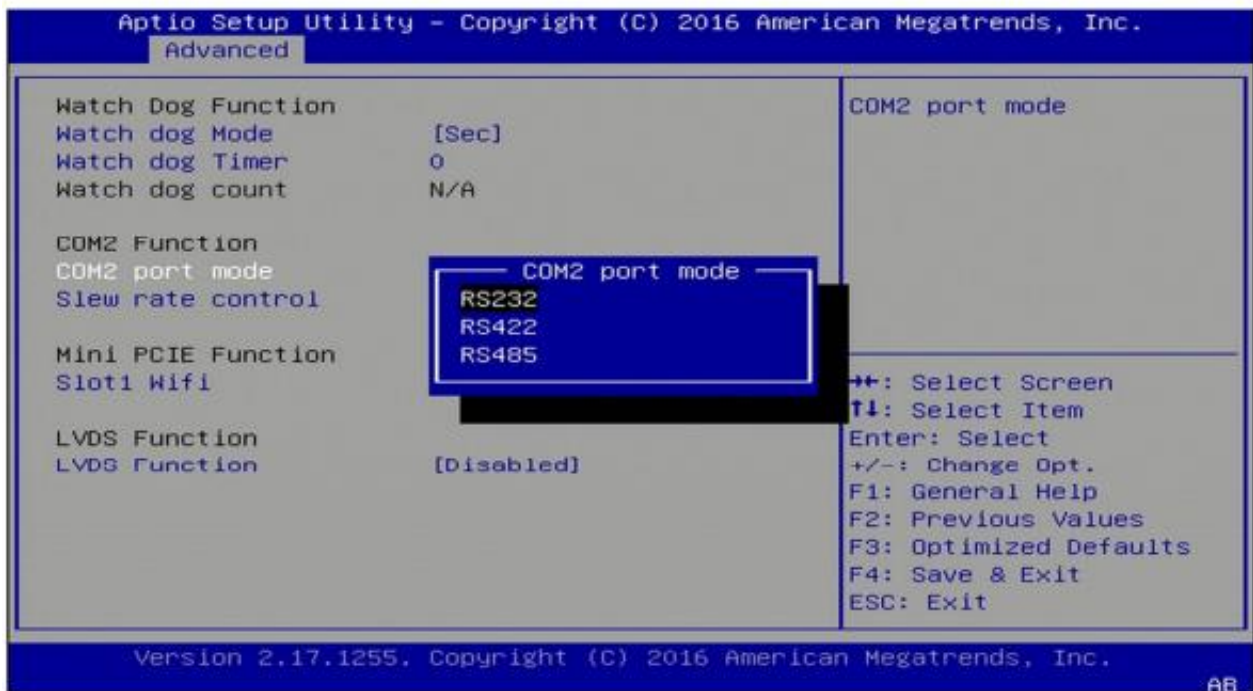
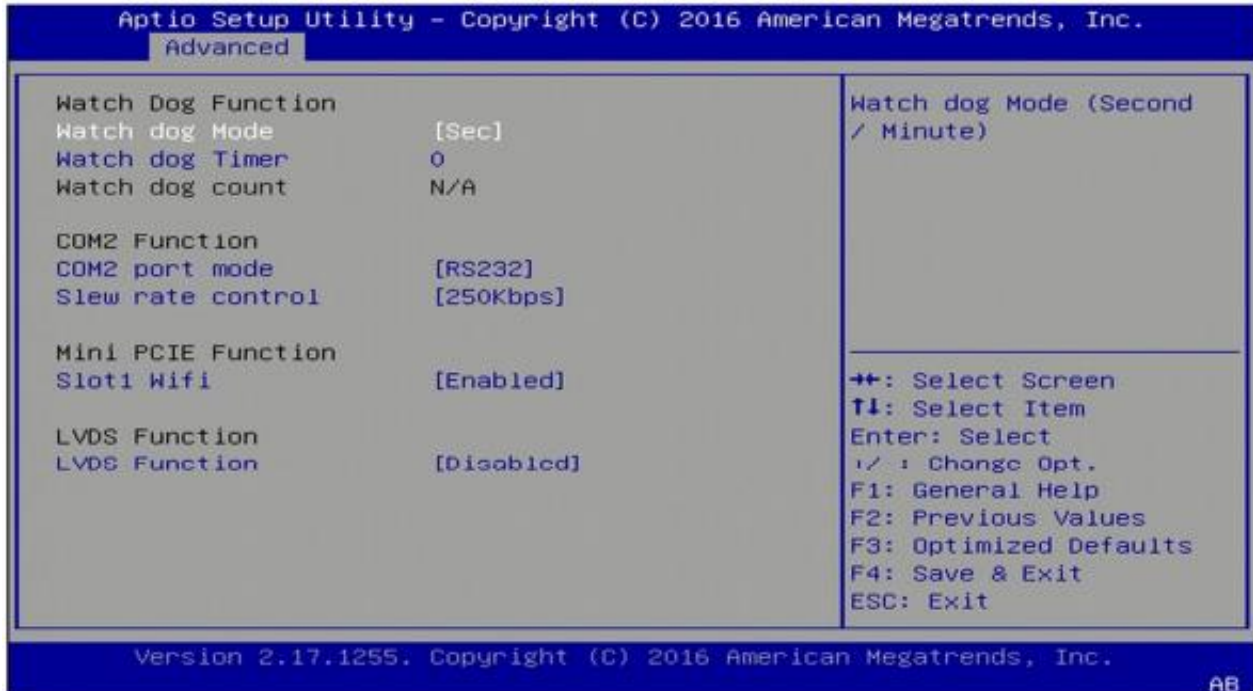

## 4.4.8 Serial Console Redirection

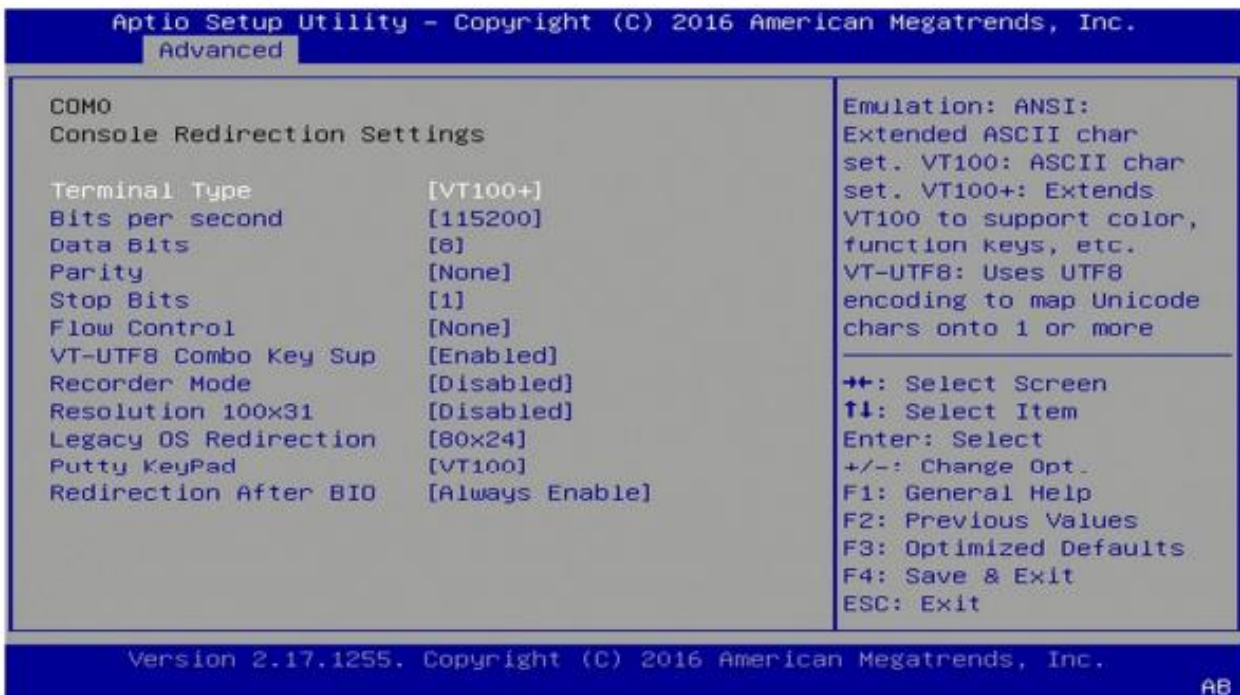
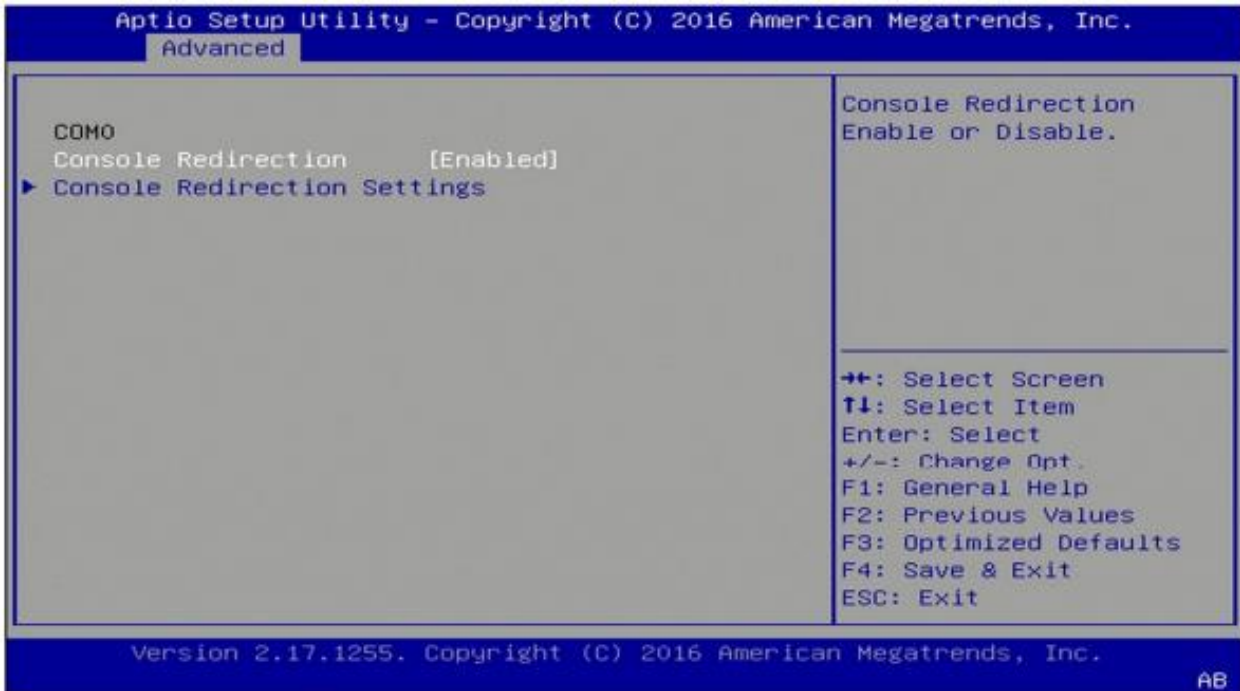

## 4.4.9 NVMe Configuration

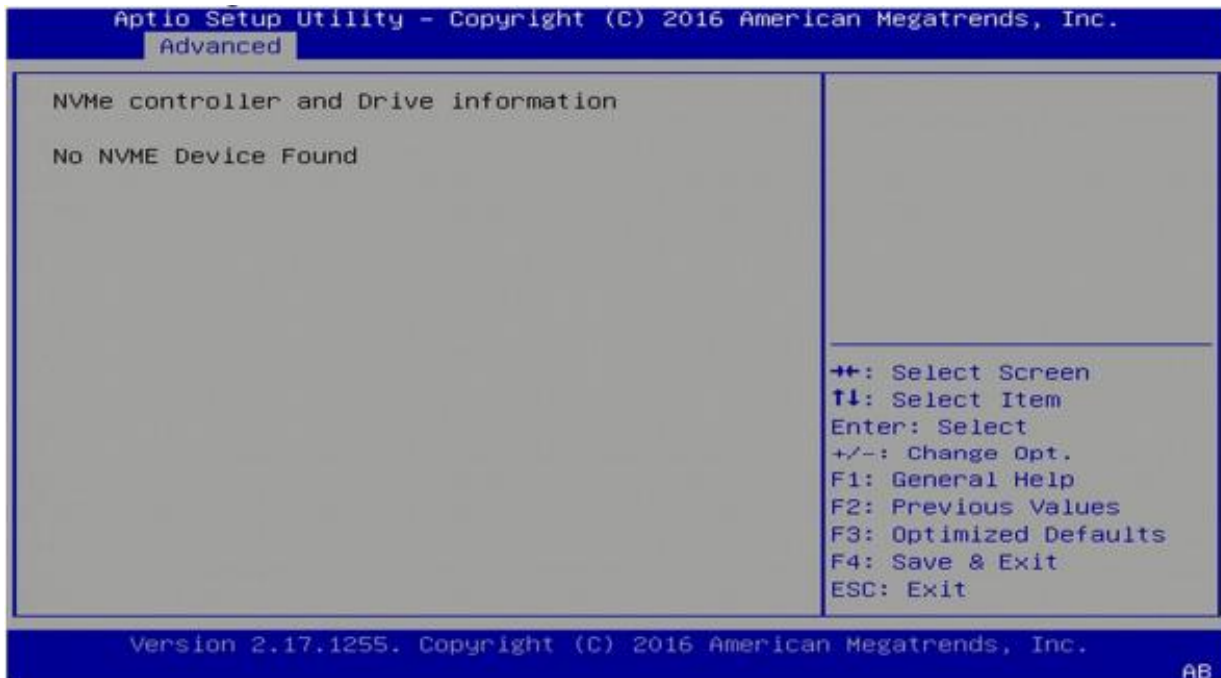

## 4.4.10 USB Configuration

Aptio Setup Utility - Copyright (C) 2016 American Megatrends, Inc.  
Advanced

USB Configuration		The time-out value for Control, Bulk, and Interrupt transfers.
USB Module Version	14	
USB Controllers:	1 XHCI	
USB Devices:	1 Keyboard	
Legacy USB Support		Select Screen
XHCI Hand-off		Select Item
USB Mass Storage Driver		Enter: Select
USB hardware delays a		+/-: Change Opt.
USB transfer time-out	[20 sec]	F1: General Help
Device reset time-out	[20 sec]	F2: Previous Values
Device power-up delay	[Auto]	F3: Optimized Defaults
		F4: Save & Exit
		ESC: Exit

Version 2.17.1255. Copyright (C) 2016 American Megatrends, Inc. AB

## 4.4.11 CSM Configuration

Aptio Setup Utility - Copyright (C) 2016 American Megatrends, Inc.  
Advanced

Compatibility Support Module Configuration		UPON REQUEST - GA20 can be disabled using BIOS services. ALWAYS - do not allow disabling GA20; this option is useful when any RT code is executed above 1MB.
CSM Support	[Enabled]	
CSM16 Module Version	07.79	
GateA20 Active	[Upon Request]	
Option ROM Messages	[Force BIOS]	
INT19 Trap Response	[Immediate]	
Boot option filter	[UEFI and Legacy]	++: Select Screen
Option ROM execution		↑↓: Select Item
Network	[Do not launch]	Enter: Select
Storage	[Legacy]	+/-: Change Opt.
Video	[Legacy]	F1: General Help
Other PCI devices	[UEFI]	F2: Previous Values
		F3: Optimized Defaults
		F4: Save & Exit
		ESC: Exit

Version 2.17.1255. Copyright (C) 2016 American Megatrends, Inc. AB

## 4.4.12 SATA Configuration

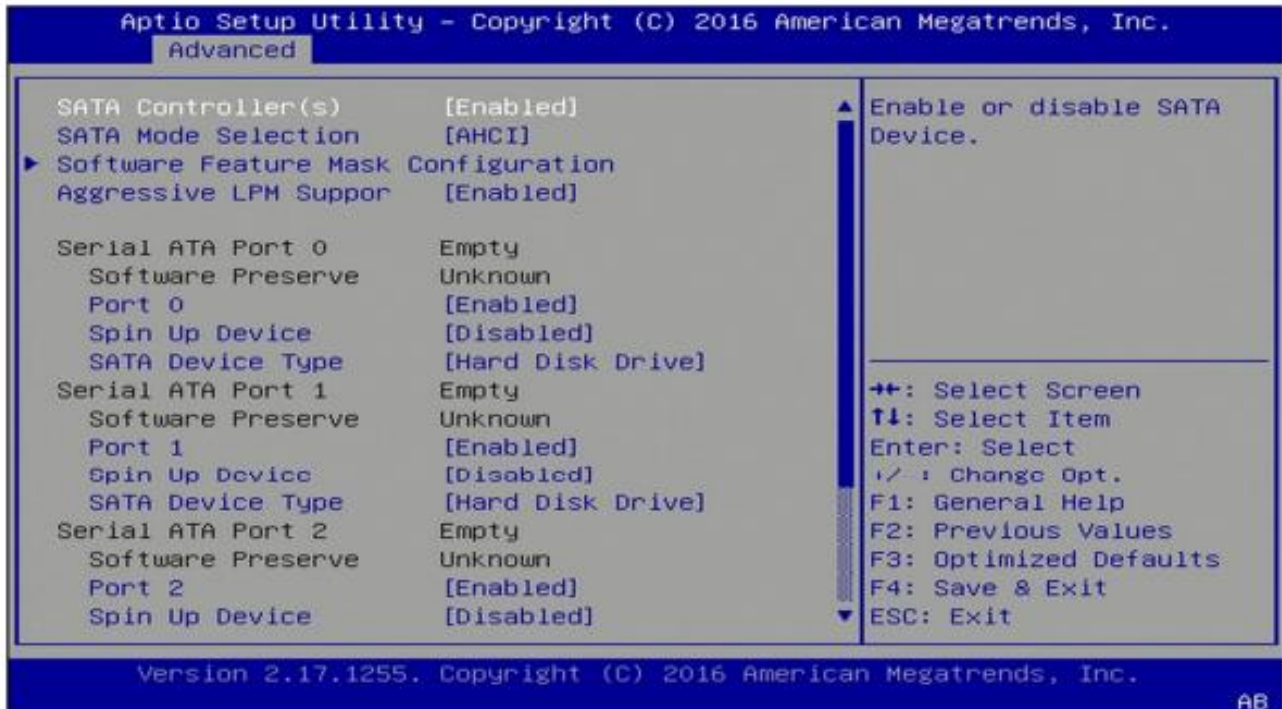

## 4.5 Chipset Menu

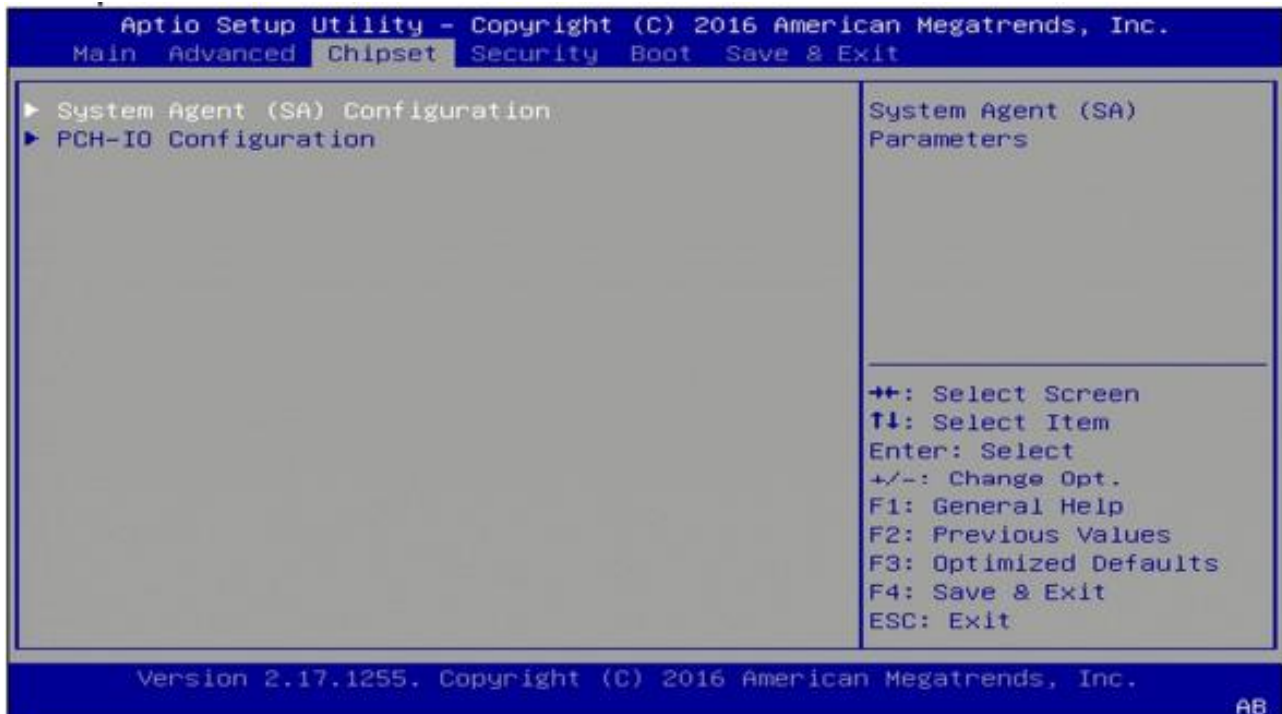

## 4.5.1 System Agent (SA) Configuration

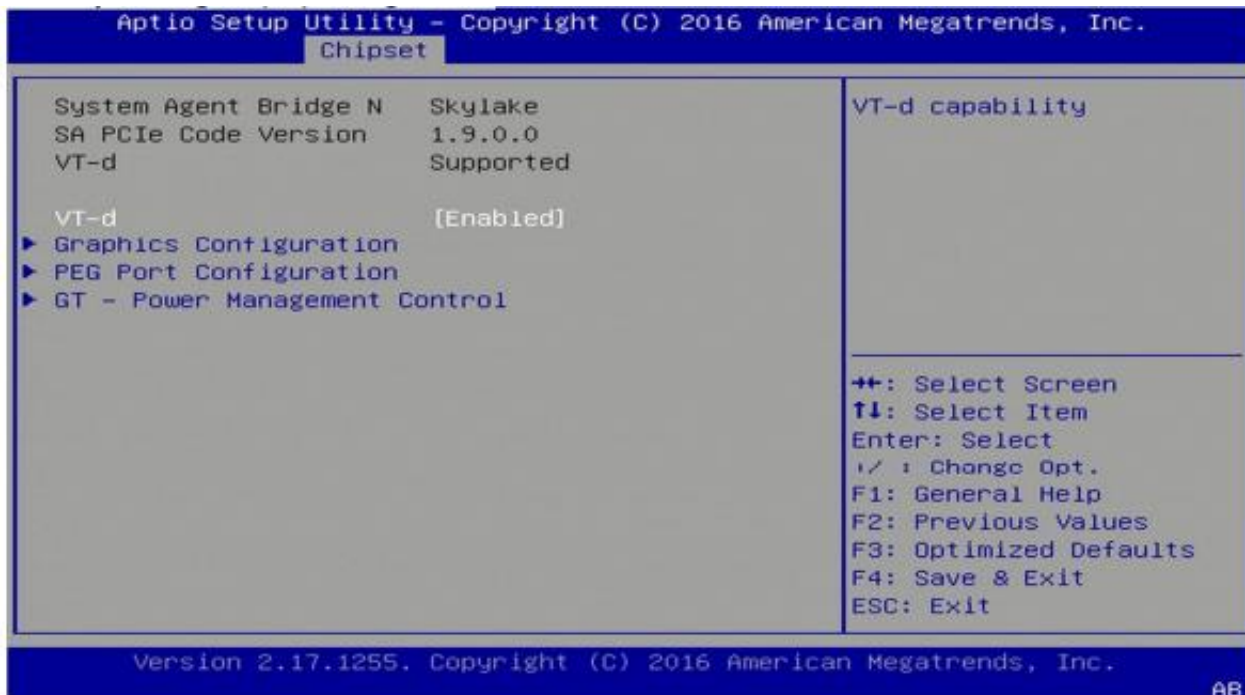

### 4.5.1.1 Graphics Configuration

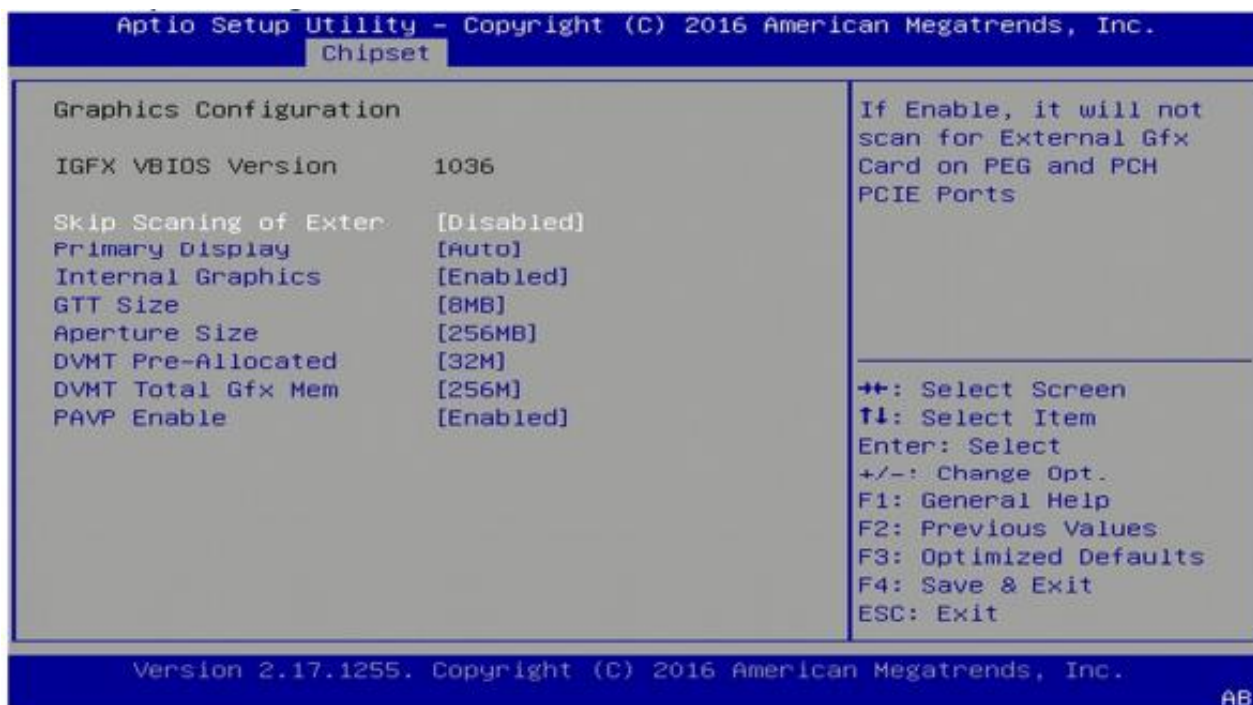



## 4.5.1.2 PEG Port Configuration

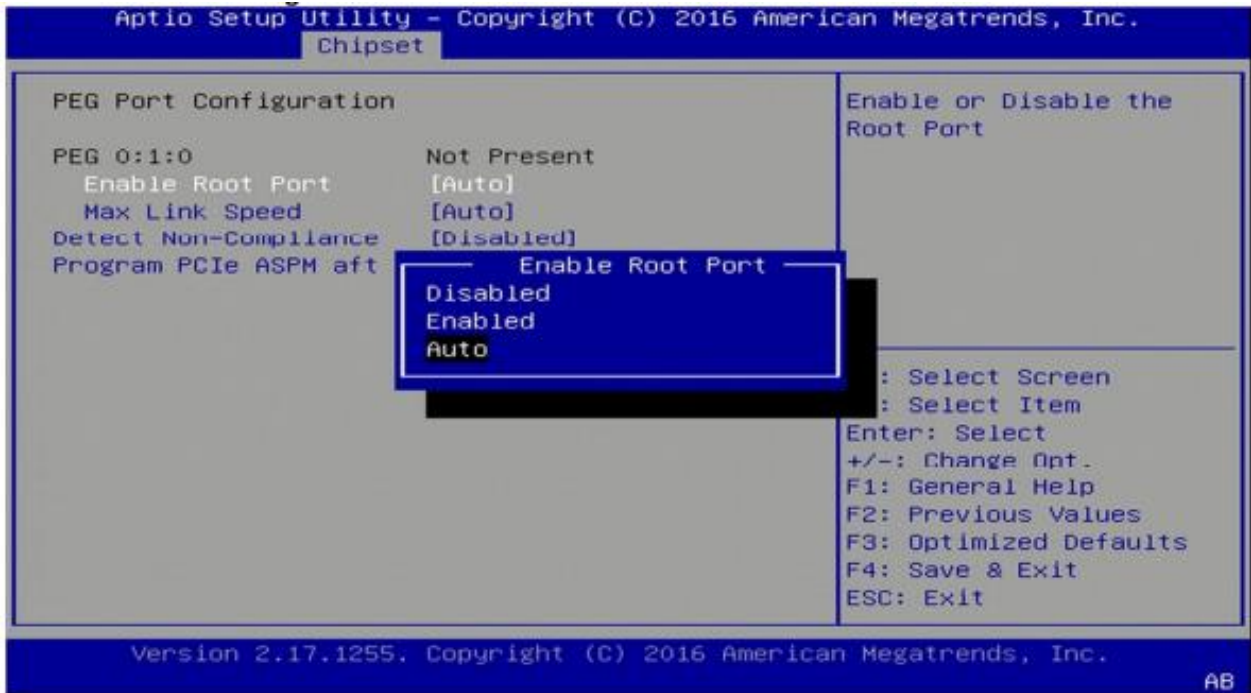

## 4.5.1.3 GT-Power Management Control

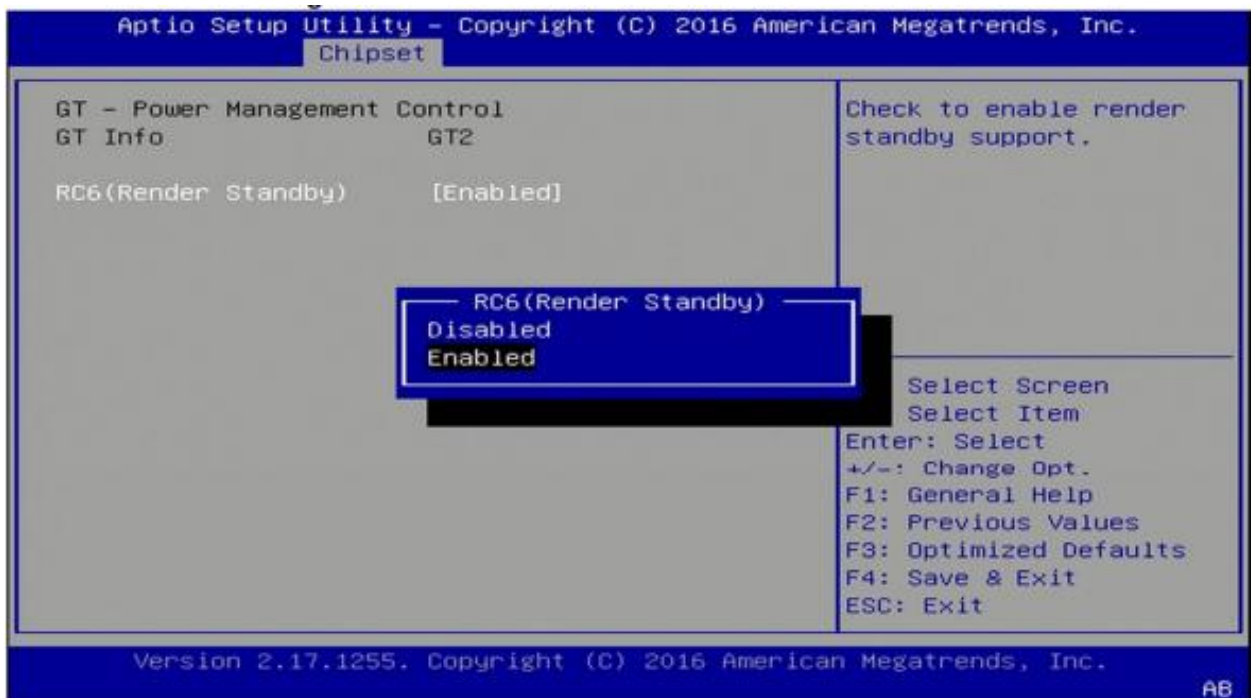

## 4.5.2 PCH-IO Configuration

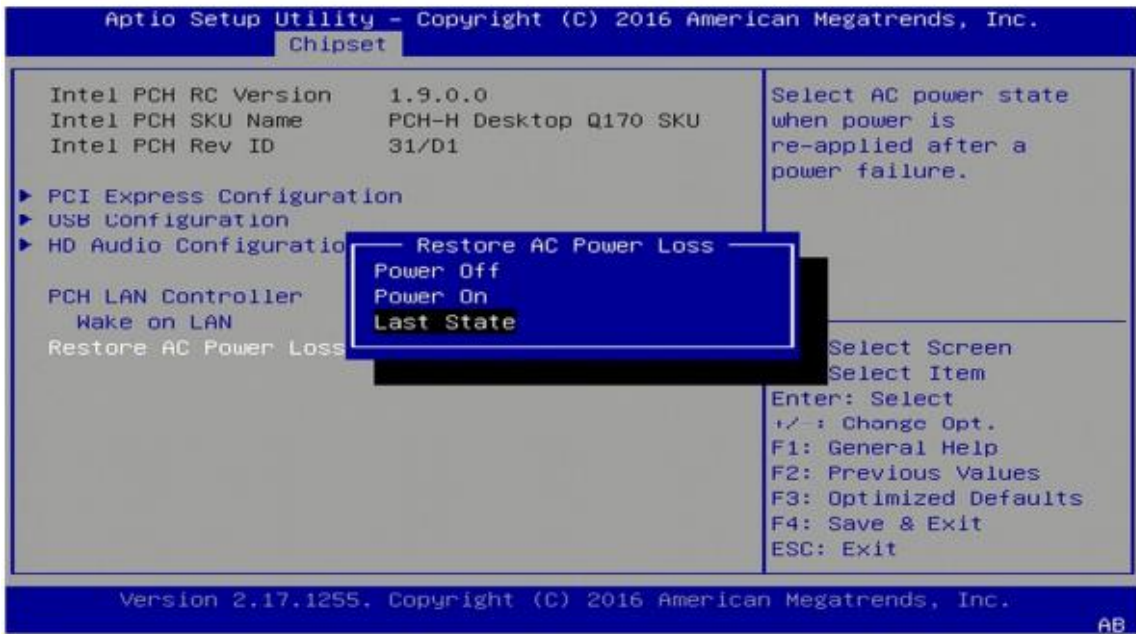
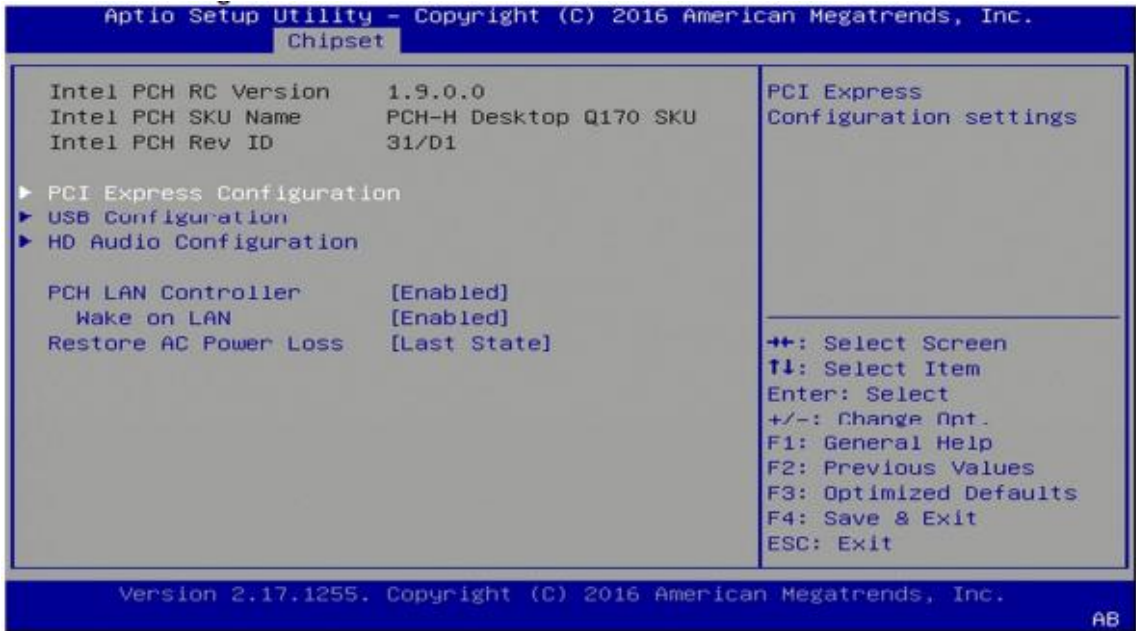

## 4.5.2.1 PCI Express Configuration

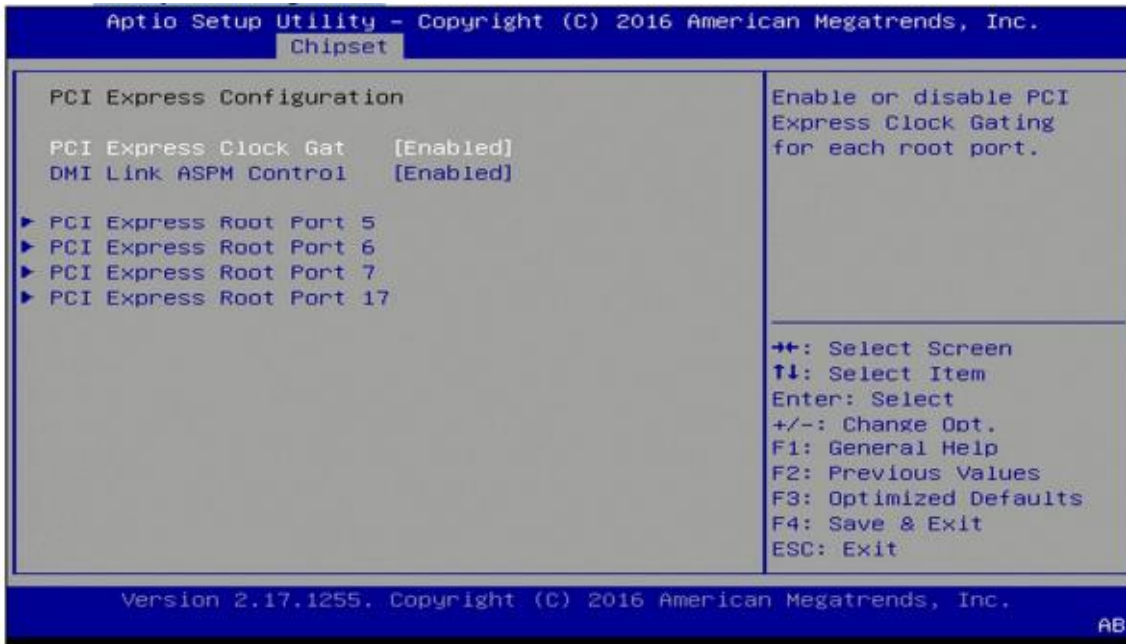

## 4.5.2.2 USB configuration

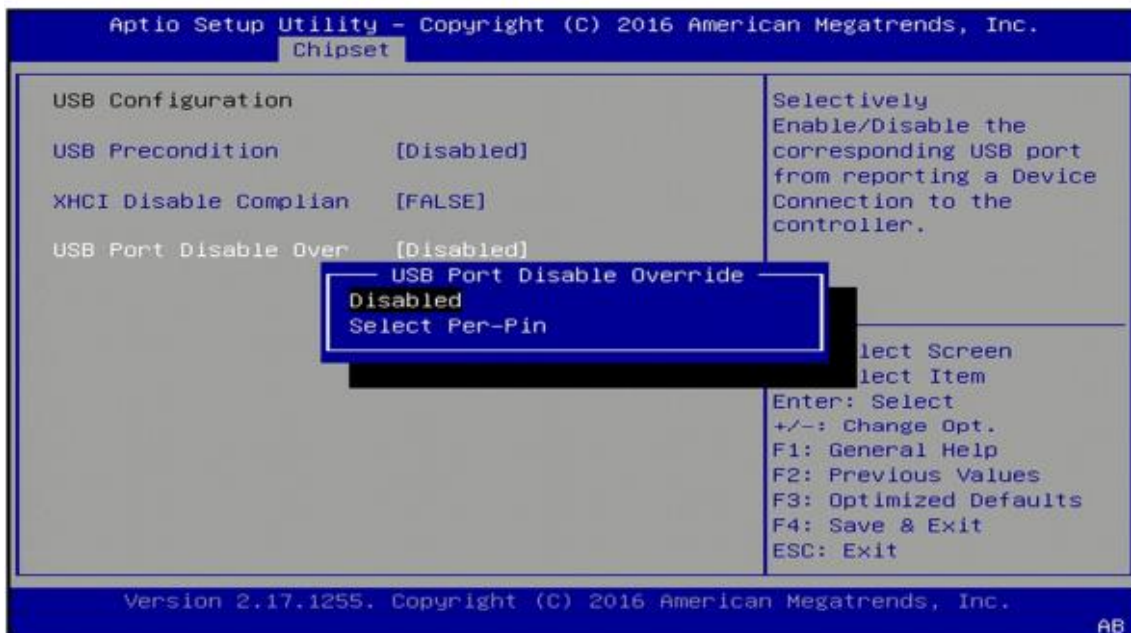
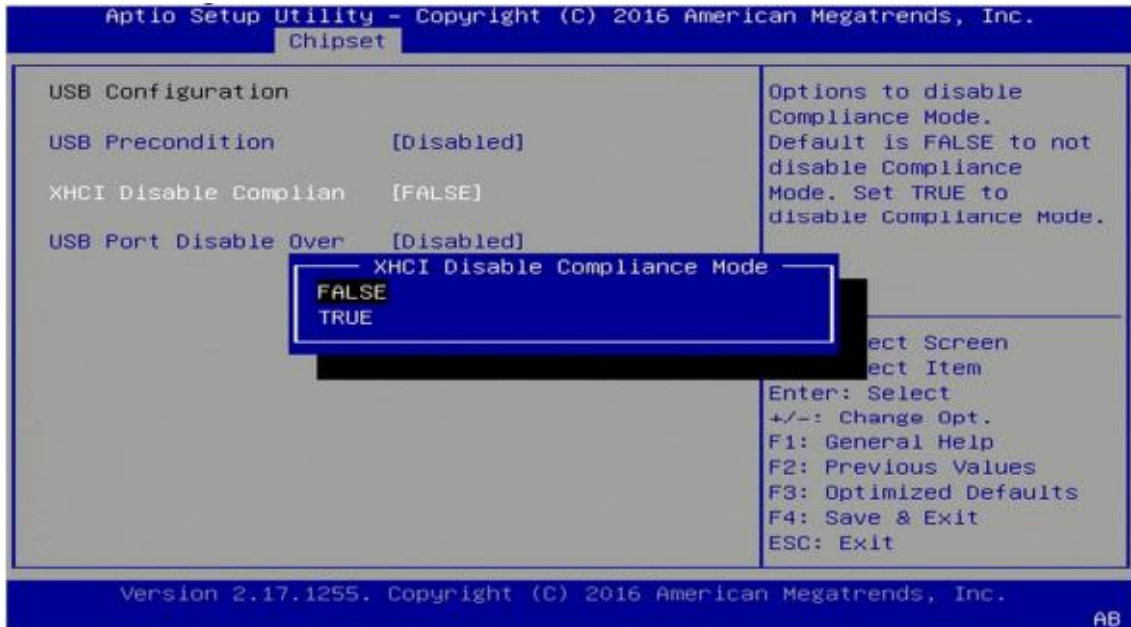

## 4.5.2.3 HD Audio Configuration

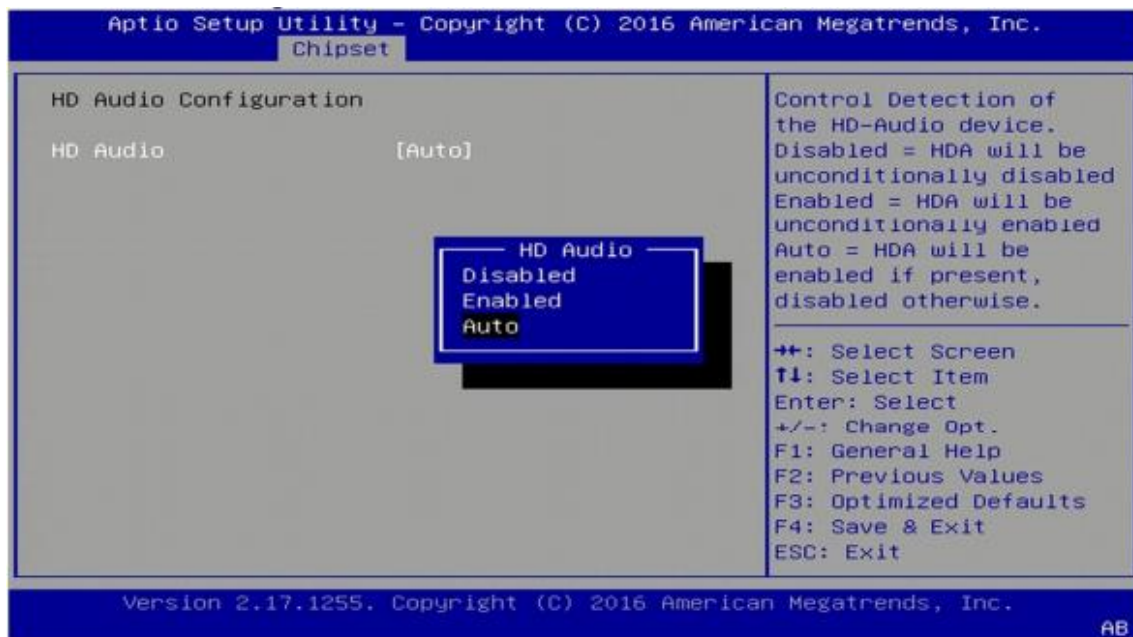

## 4.6 Security Menu

Use the Security Menu to establish system passwords

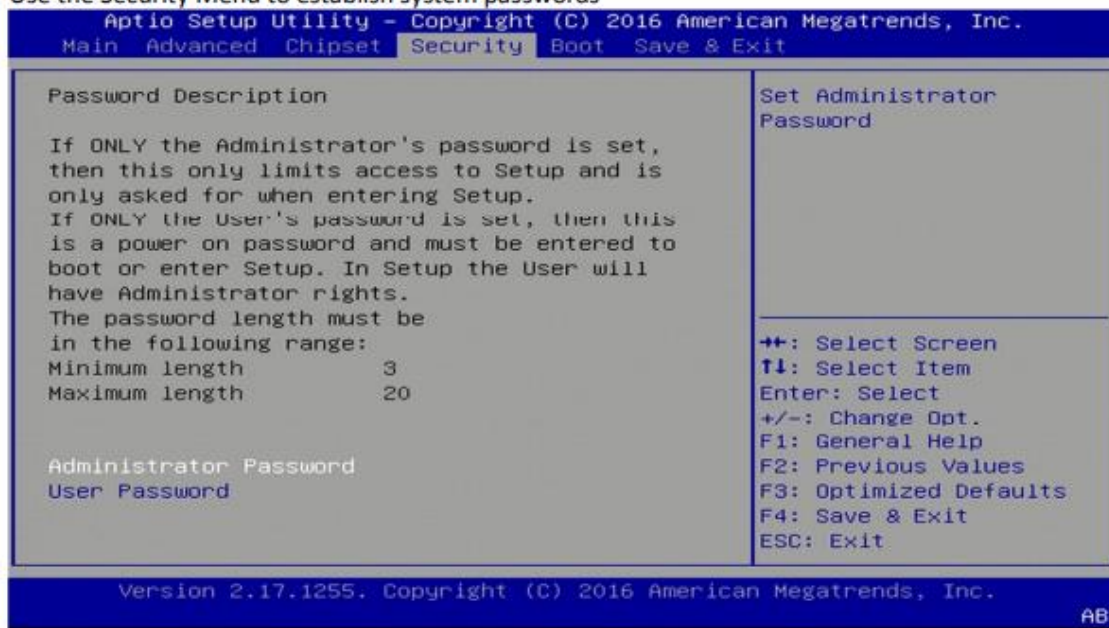

### Administrator Password

Set administrator password.

### User Password

Set user Password.

## 4.7 Boot Menu

This section is used to configure the boot features.

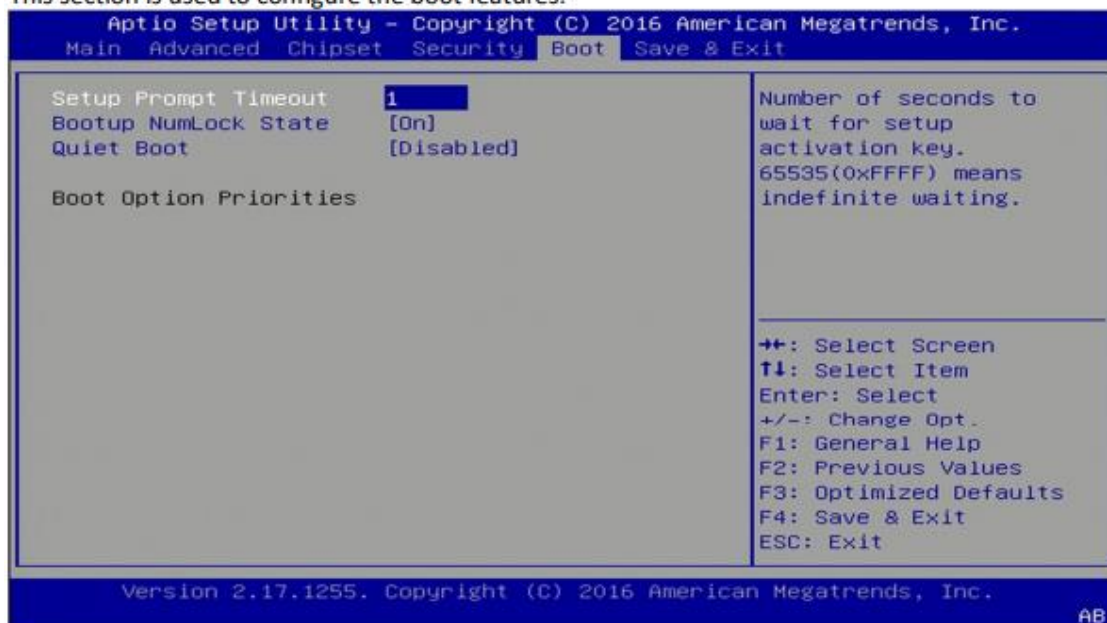

### Setup Prompt Timeout

Number of seconds to wait for setup activation key. 65535 (0xFFFF) means indefinite waiting.

### Bootup NumLock State

Select the keyboard NumLock state

### Quiet Boot

Enables or disables quiet boot option

## 4.8 Save & Exit

This screen provides functions for handling changes made to the BIOS settings and the exiting of the Setup program.



### Save Changes and Exit

Exit system setup after saving the changes

### Discard Changes and Exit

Exit system setup without saving changes

### Restore Defaults

Restore/Load default values for all the setup options