

ADLE3800SEC

Manual

Rev. 1.0



Contents

| | | |
|-------|--|----|
| 0 | Document History..... | 6 |
| 1 | Introduction | 7 |
| 1.1 | Important Notes | 7 |
| 1.2 | Technical Support..... | 7 |
| 1.3 | Warranty | 7 |
| 1.4 | Return Authorization | 7 |
| 1.5 | Description of Safety Symbols..... | 8 |
| 1.6 | RoHS | 8 |
| 1.7 | FCC Approval for Canada | 8 |
| 1.8 | FCC Approvals for the United States of America | 8 |
| 2 | Overview | 9 |
| 2.1 | Features..... | 9 |
| 2.2 | Feature List..... | 10 |
| 2.3 | Specifications and Documents | 11 |
| 3 | Detailed Description..... | 12 |
| 3.1 | CPU | 12 |
| 3.2 | Memory..... | 12 |
| 3.3 | M.2..... | 12 |
| 4 | Connectors..... | 13 |
| 4.1 | Connector Map | 14 |
| 4.2 | Front Panel Connectors..... | 15 |
| 4.2.1 | Power Supply..... | 15 |
| 4.2.2 | USB..... | 16 |
| 4.2.3 | LAN..... | 18 |
| 4.3 | Memory and internal connectors | 19 |
| 4.3.1 | DRAM Memory | 19 |
| 4.3.2 | M.2 2242 (Keying B) | 20 |
| 4.3.3 | Display Port..... | 22 |
| 4.3.4 | BAseCon140 Connector | 23 |
| 4.3.5 | External Battery | 26 |
| 4.3.6 | FAN Connector | 27 |
| 4.4 | LED Signaling | 28 |
| 4.4.1 | RGB LED | 28 |
| 4.4.2 | Harddisk-LED..... | 29 |
| 4.4.3 | TwinCAT-LED..... | 30 |
| 5 | BIOS Settings..... | 31 |
| 5.1 | General Remarks..... | 31 |
| 5.2 | Main | 32 |
| 5.3 | Advanced..... | 33 |
| 5.3.1 | ACPI Settings..... | 35 |
| 5.3.2 | H/W Monitor | 36 |
| 5.3.3 | CPU Configuration | 37 |
| 5.3.4 | PPM Configuration..... | 40 |
| 5.3.5 | SATA Configuration | 41 |
| 5.3.6 | Miscellaneous Configuration..... | 42 |
| 5.3.7 | Network Stack..... | 43 |

Contents

| | | |
|--------|--|----|
| 5.3.8 | Power Controller Options..... | 44 |
| 5.3.9 | CSM Configuration | 45 |
| 5.3.10 | Advanced-Menü-NVMe Configuration | 46 |
| 5.3.11 | SDIO Configuration..... | 47 |
| 5.3.12 | USB Configuration | 48 |
| 5.3.13 | Security Configuration | 49 |
| 5.3.14 | Intel(R) I210 Gigabit Network Connection | 50 |
| 5.3.15 | Driver Health | 52 |
| 5.4 | Chipset..... | 54 |
| 5.4.1 | North Bridge..... | 55 |
| 5.4.2 | South Bridge | 59 |
| 5.5 | Security | 63 |
| 5.5.1 | Secure Boot menu | 64 |
| 5.6 | Boot..... | 66 |
| 5.6.1 | Advanced Fixed Boot Order Parameters..... | 67 |
| 5.7 | Save & Exit | 68 |
| 5.8 | BIOS Update..... | 69 |
| 6 | Mechanical Drawings..... | 70 |
| 6.1 | PCB: Outlines | 70 |
| 6.2 | PCB: Die Center | 71 |
| 7 | Technical Data | 72 |
| 7.1 | Elektrische Daten..... | 72 |
| 7.2 | Environmental Conditions..... | 72 |
| 7.3 | Thermal Specifications | 73 |
| I | Annex: Post-Codes | 75 |
| II | Annex: Resources..... | 76 |
| | Interrupt | 76 |
| | PCI Devices..... | 76 |

Preliminary

0 Document History

| Version | Changes |
|---------|------------------------|
| 0.1 | first pre-release |
| 1.0 | first released version |

All company names, brand names, and product names referred to in this manual are registered or unregistered trademarks of their respective holders and are, as such, protected by national and international law.

1 Introduction

1.1 Important Notes

Please read this manual carefully before you begin installation of this hardware device. To avoid Electrostatic Discharge (ESD) or transient voltage damage to the board, adhere to the following rules at all times:

- You must discharge your body from electricity before touching this board.
- Tools you use must be discharged from electricity as well.
- Please ensure that neither the board you want to install, nor the unit on which you want to install this board, is energized before installation is completed.
- Please do not touch any devices or components on the board.

WARNING

As soon as the board is connected to a working power supply, touching the board may result in electrical shock, even if the board has not been switched on yet. Please also note that the mounting holes for heat sinks are connected to ground, so when using an externally AC powered device, a substantial ground plane differential can occur if the external device's AC power supply or cable does not include an earth ground. This could also result in electrical shock when touching the device and the heat sink simultaneously.

1.2 Technical Support

Technical support for this product can be obtained in the following ways:

- By contacting our support staff at +1 858-490-0597 or +49 (0) 271 250 810 0
- By contacting our staff via e-mail at support@adl-usa.com or support@adl-europe.com
- Via our website at www.adl-usa.com/support or www.adl-europe.com/support

1.3 Warranty

This product is warranted to be free of defects in workmanship and material. ADL Embedded Solutions' sole obligation under this warranty is to provide replacement parts or repair services at no charge, except shipping cost. Such defects which appear within 12 months of original shipment of ADL Embedded Solutions will be covered, provided a written claim for service under warranty is received by ADL Embedded Solutions no less than 30 days prior to the end of the warranty period or within 30 days of discovery of the defect – whichever comes first. Warranty coverage is contingent upon proper handling and operation of the product. Improper use such as unauthorized modifications or repair, operation outside of specified ratings, or physical damage may void any service claims under warranty.

1.4 Return Authorization

All equipment returned to ADL Embedded Solutions for evaluation, repair, credit return, modification, or any other reason must be accompanied by a Return Material Authorization (RMA) number. ADL Embedded Solutions requires a completed RMA request form to be submitted in order to issue an RMA number. The form can be found under the Support section at our website: www.adl-usa.com or www.adl-europe.com. Submit the completed form to support@adl-usa.com or fax to +1 858-490-0599 for the USA office, or to rma@adl-europe.com or fax to +49 (0) 271 250 810 20 to request an RMA from the European office in Germany. Following a review of the information provided, ADL Embedded Solutions will issue an RMA number.

1.5 Description of Safety Symbols

The following safety symbols are used in this documentation. They are intended to alert the reader to the associated safety instructions.

 **DANGER**

DANGER indicates a hazardous situation which, if not avoided, will result in death or serious injury.

 **WARNING**

WARNING indicates a hazardous situation which, if not avoided, could result in death or serious injury.

 **CAUTION**

CAUTION indicates a hazardous situation which, if not avoided, could result in minor or moderate injury.

 **NOTICE**

NOTICE is used to address practices not related to physical injury.

1.6 RoHS

The PCB and all components are RoHS compliant (RoHS = Restriction of Hazardous Substances Directive). The soldering process is lead free.

1.7 FCC Approval for Canada

FCC: Canadian Notice

This equipment does not exceed the Class A limits for radiated emissions as described in the Radio Interference Regulations of the Canadian Department of Communications.

1.8 FCC Approvals for the United States of America

FCC: Federal Communications Commission Radio Frequency Interference Statement

This equipment has been tested and found to comply with the limits for a Class A digital device, pursuant to Part 15 of the FCC Rules. These limits are designed to provide reasonable protection against harmful interference when the equipment is operated in a commercial environment. This equipment generates, uses, and can radiate radio frequency energy and, if not installed and used in accordance with the instruction manual, may cause harmful interference to radio communications. Operation of this equipment in a residential area is likely to cause harmful interference in which case the user will be required to correct the interference at his own expense.

2 Overview

2.1 Features

The ADLE3800SEC is designed as mini computing unit. It combines basic I/O functions, onBoard memory and an efficient CPU on a minimum of space.

The frontpanel provides standard interfaces, such as DisplayPort/HDMI, 1x USB2.0, 1x USB3.0 and 2x Gbit-LAN interfaces.

With the BAsCon140 connector on its reverse side, the ADLE3800SEC provides a flexible option for additional IOs. The connector offers up to 8 PCIe-lanes, from which 4 can be muxed with SATA and further 4 with USB3.0 signals. A backplane takes over the IO configuration. All configuration data are stored in an EEPROM on the backplane. The backplane communicates the data to the board via SMB and therefore enables an uncomplicated and self-configuring IO extension.

An RGB LED signals the state of powercontroller. Input voltage is 24V.

Even though the ADLE3800SEC is designed in an extremely compact and small format, it offers the full motherboard functionality.

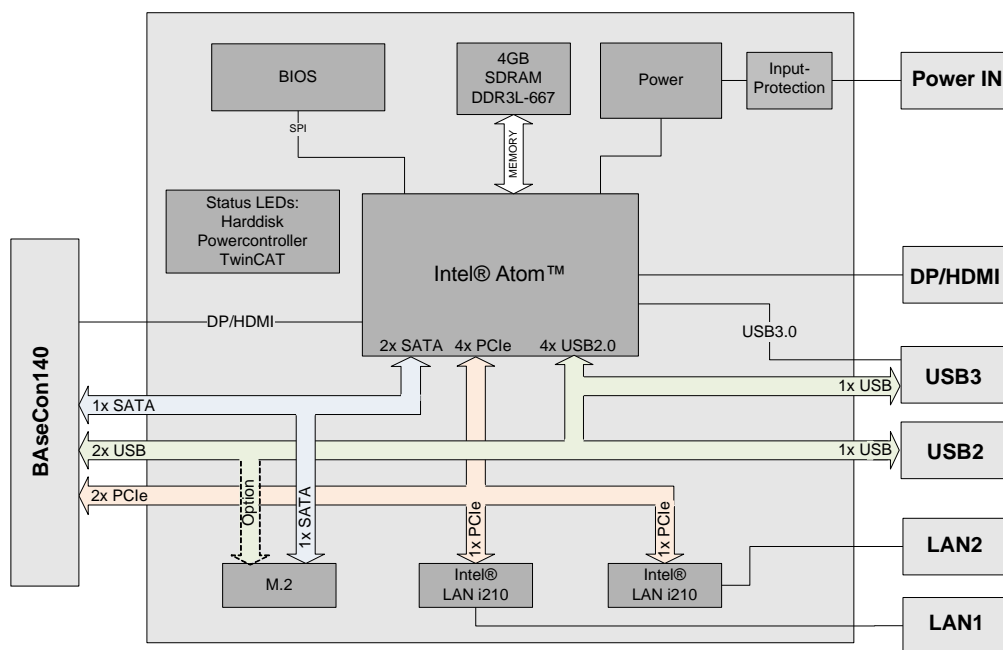

2.2 Feature List

| ADLE3800SEC | 3,5"-Board |
|---------------------|---|
| CPU | Atom™ E3845 (QC, 2M, 1.91 GHz), TDP 10W |
| | Atom™ E3827 (DC, 1M, 1.75 GHz), TDP 8W |
| | Atom™ E3815 (SC, 1M, 1.46 GHz), TDP 5W |
| Memory | OnBoard DRAM-1,35V / DDR3 (depending on CPU up to 1333MHz, up to 2GB) |
| | OnBoard DRAM-1,35V / DDR3 (depending on CPU up to 1333MHz, up to 4GB) |
| I/O | 2x LAN 10/100/1000 via frontpanel |
| | 1x USB 2.0 via frontpanel |
| | 1x DisplayPort via frontpanel |
| | 1x USB 3.0 via frontpanel |
| | 1x M.2 Key B 2242 with SATA 2.0 (3G) |
| | 1x BAseCon140 with DisplayPort, 1x SATA 2.0, 2x PCIe x1, 1x USB 2.0, SM-Bus, 1-Wire-Interface |
| Graphics | HDMI1.4 / DVI: 1920 x 1200 |
| | DP1.1a: 2560 x 1600 |
| RTC | With external CMOS battery (via 2-pin connector or backplane) |
| BIOS | AMI® Aptio V |
| Power Supply | 16V - 30V input voltage range |
| | Overvoltage- and undervoltage protection |
| | Reverse voltage protection |
| | Not galvanically isolated |
| Format | 75 mm x 75 mm |

NOTICE

The feature list specifies all suitable CPUs. Their actual availability is manufacturer-specific.

2.3 Specifications and Documents

In making this manual and for further reading of technical documentation, the following documents, specifications and web-pages were used and are recommended.

- PCI specification
Version 2.3 bzw. 3.0
www.pcisig.com
- PCI Express® Base specification
Version 2.0
www.pcisig.com
- ACPI specification
Version 3.0
www.acpi.info
- ATA/ATAPI specification
Version 7 Rev. 1
www.t13.org
- USB specifications
www.usb.org
- SM-Bus specification
Version 2.0
www.smbus.org
- Intel® Chip Description
Intel® Atom™ Processor E3800 Product Family datasheet
www.intel.com
- Intel® Chip Description
i210 Datasheet
www.intel.com
- American Megatrends®
Aptio™ Text Setup Environment (TSE) User Manual
www.ami.com
- American Megatrends®
Aptio™ 4.x Status Codes
www.ami.com
- M.2 specification
Version 1.0
www.pcisig.com
- DisplayPort specification
Version 1.2
www.vesa.org

3 Detailed Description

3.1 CPU

The motherboard employs an Intel® Atom™ processor of the E3800 family, which is a system-on-chip (SoC) being optimized for low power consumption, while at the same time providing state-of-the-art computing performance.

The processors include a second level cache of 256 KByte. They also offer many features known from the desktop range such as SSE4.1/4.2, loadable microcode etc.

The Atom™ CPU operates in an extended range of thermal conditions and therefore is capable for use in industrial systems.

3.2 Memory

The ADLE3800SEC is equipped with four fixed DRAM memory modules.

Depending on the product variant, there are different memory modules in use, as there are a DDR3 variant with 2GByte and another one with 4GByte memory. The ADLE3800SEC supports a maximum frequency of 1333MHz, depending on the CPU type.

3.3 M.2

Depending on the type of card, add-in cards, which comply with the M.2 specification, come in a very small format and with flexible dimensions. Different key IDs support different interfaces, as there are up to four PCI Express lanes, SATA and/or USB3.0 (see table below).

M.2 cards can be easily inserted: just plug them into the slot and fix it with a fixing screw.

Cards of different types have different keyings. Depending on the supported type, one port can receive add-in cards of one or various types.

| Key ID | Available Interfaces |
|---------------|--|
| A | PCIe x2, USB 2.0, I ² C and DP |
| B* | PCIe x2, SATA, USB 2.0/3.0 Audio, UIM, HSIC, SSIC, I ² C, SMBus |
| C, D | Reserved |
| E | PCIe x2, USB2.0, I ² C, SDIO, UART, PCM |
| F | Future Memory Interface (FMI) |
| G, H, J, K, L | Reserved |
| M | PCIe x4, SATA and SMBus |

* With its M.2 socket the ADLE3800SEC supports keying B M.2 modules.

NOTICE

For optimal driver compatibility we recommend the use of a Microsoft® Windows® 8 operating system.
If you use an add-in card, which is not or not fully supported, the BIOS will display an error message.

4 Connectors

This section describes all the connectors found on the ADLE3800SEC.

NOTICE

Please consider the requirements on the cabling!

For most interfaces, the cables must meet certain requirements. For instance, USB 2.0 requires twisted and shielded cables to reliably maintain full speed data rates. Restrictions on maximum cable length are also in place for many high speed interfaces and for power supply. Please refer to the respective specifications and use suitable cables at all times.

Preliminary

4.1 Connector Map

Please use the connector map below for quick reference. Only connectors on the component side are shown. For more information on each connector refer to the table below.

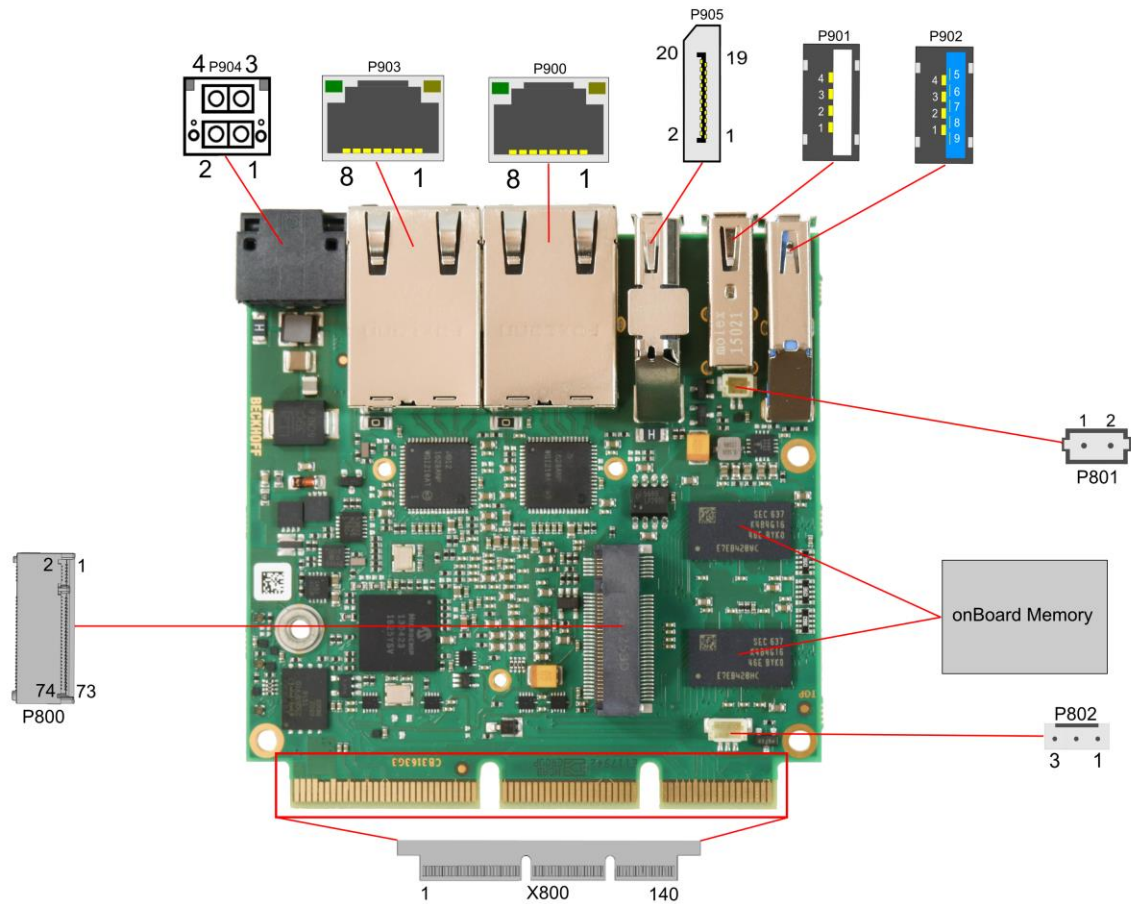

| Ref.-No. | Function | Page |
|---------------|-----------------------|-------|
| U500/01/02/03 | "DRAM Memory" | p. 19 |
| P800 | "M.2 2242 (Keying B)" | p. 20 |
| P801 | "External Battery" | p. 26 |
| P802 | "FAN Connector" | p. 27 |
| P900/03 | "LAN" | p. 18 |
| P901/02 | "USB" | p. 16 |
| P904 | "Power Supply" | p. 15 |
| P905 | "Display Port" | p. 22 |
| X800 | "BAsCon140 Connector" | p. 23 |

4.2 Front Panel Connectors

A range of standard connectors are available: You can connect displays, USB, LAN etc. The following connectors are located on the front panel of the ADLE3800SEC.

4.2.1 Power Supply

The power supply of the ADLE3800SEC is realized via a 2x2pin connector (P20THR-1787014). The main 24V power lines are assigned to pin 3.

| Manufacturer | Description | Mating Connector |
|--------------|----------------|--------------------------------|
| Phoenix | P20THR-1787014 | DFMC 1,5/ 2-ST-3,5-LR- 1790292 |

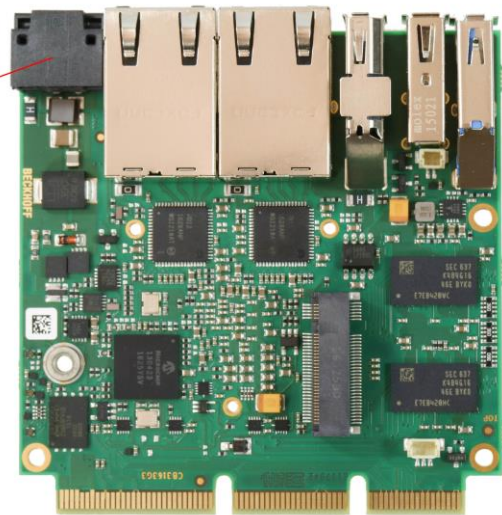
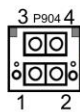

NOTICE

Since this is a 90-degree connector, the symbol in the drawing below represents the connector face as seen from the side (PCB on bottom) rather than from above.

| Description | Name | Pin | Name | Description | |
|-------------|----------|-----|------|-------------|------------------|
| PC Start | PC_START | 1 | 3 | Vin | Power Supply 24V |
| PC Status | PC-AKTIV | 2 | 4 | GND | Ground |

4.2.2 USB

USB channels 1 and 2 are provided via two standard USB connectors.

USB channel 1 supports USB 2.0 and provides up to 500 mA current.

USB channel 2 supports USB 3.0. Contrary to the USB3.0 specification, channel 2 only provides 500mA current. For higher power requirements, you must use devices with an integrated power supply.

Both interfaces, USB 2.0 and USB 3.0, are protected by an electronically resettable fuse.

You may note that the setting of USB keyboard or USB mouse support in the BIOS-setup is only necessary and advisable, if the OS offers no USB-support. BIOS-setup can be changed with a USB keyboard without enabling USB keyboard support. Running Windows with these features enabled may lead to significant performance or functionality limitations.

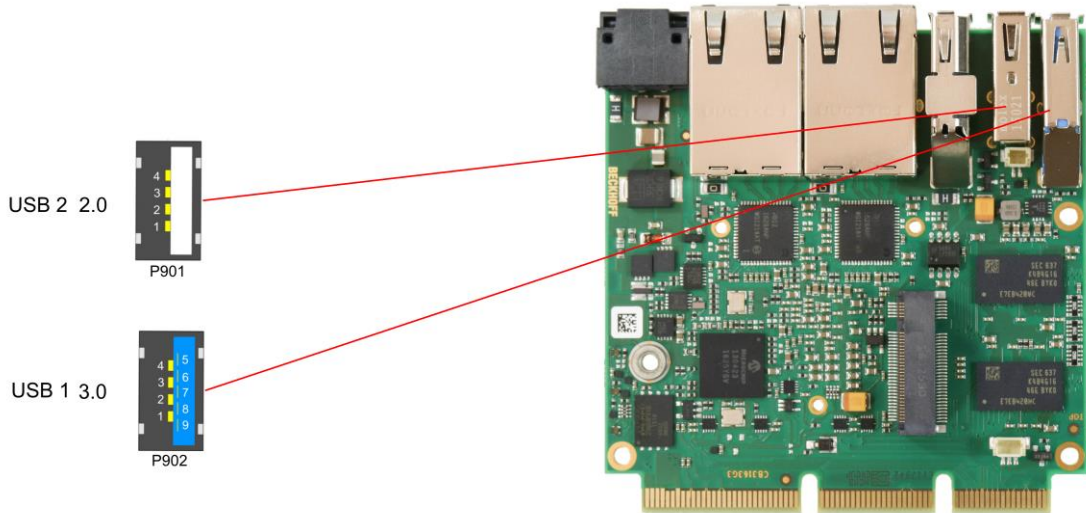

NOTICE

Both Standard USB ports are protected by a combined overcurrent detection. In case of an overcurrent, even at one port, the overcurrent protection will turn off both USB ports.

Pinout USB2.0 connector for channel X:

| Pin | Name | Description |
|-----|-------|--------------------|
| 1 | VCC | 5 volt for USBX |
| 2 | USBX# | minus channel USBX |
| 3 | USBX | plus channel USBX |
| 4 | GND | ground |

Pinout USB3.0 connector for channel X:

| Pin | Name | Description |
|-----|------------|-----------------------|
| 1 | VCC | 5 volt for USBX |
| 2 | USBX# | Minus channel USBX |
| 3 | USBX | Plus channel USBX |
| 4 | GND | ground |
| 5 | StdA_SSRX- | SuperSpeed Receiver - |

| Pin | Name | Description |
|-----|------------|--------------------------|
| 6 | StdA_SSRX+ | SuperSpeed Receiver + |
| 7 | GND | ground |
| 8 | StdA_SSTX- | SuperSpeed Transmitter - |
| 9 | StdA_SSTX+ | SuperSpeed Transmitter + |

4.2.3 LAN

The module has two LAN interfaces both of which support 10BaseT, 100BaseT, and 1000BaseT compatible net components with automatic bandwidth selection. Controller chip is Intel®'s i210. Auto-cross and auto-negotiate functionality is available as is PXE and WOL.

| Manufacturer | Description | Mating Connector |
|--------------|------------------|--------------------------|
| Foxconn | JFM3811F-2101-4F | (Standard LAN connector) |

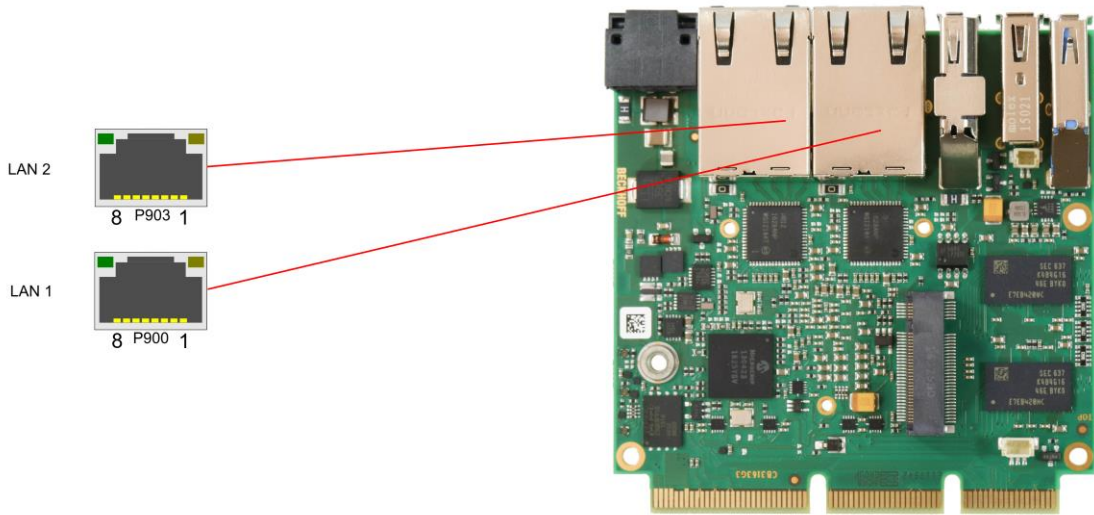

Pinout LAN 10/100/1000:

| Pin | Name | Description |
|-----|---------|----------------------|
| 1 | LAN1-0 | LAN1 channel 0 plus |
| 2 | LAN1-0# | LAN1 channel 0 minus |
| 3 | LAN1-1 | LAN1 channel 1 plus |
| 4 | LAN1-1# | LAN1 channel 1 minus |
| 5 | LAN1-2 | LAN1 channel 2 plus |
| 6 | LAN1-2# | LAN1 channel 2 minus |
| 7 | LAN1-3 | LAN1 channel 3 plus |
| 8 | LAN1-3# | LAN1 channel 3 minus |

The LEDs show activity and speed of data transfer:

| Mbit/s | flashing at data transfer | permanent |
|--------|---------------------------|-----------|
| 1000 | green | green |
| 100 | green | orange |
| 10 | green | - |

4.3 Memory and internal connectors

4.3.1 DRAM Memory

The ADLE3800SEC is equipped with four fixed DRAM memory modules DDR3-667.

Depending on the hardware variant, there are two different memory modules in use, which are one DDR3 variant with 2GByte and one DDR3L variant with 4GByte memory.

All timing parameters for different memory modules are automatically set by BIOS.

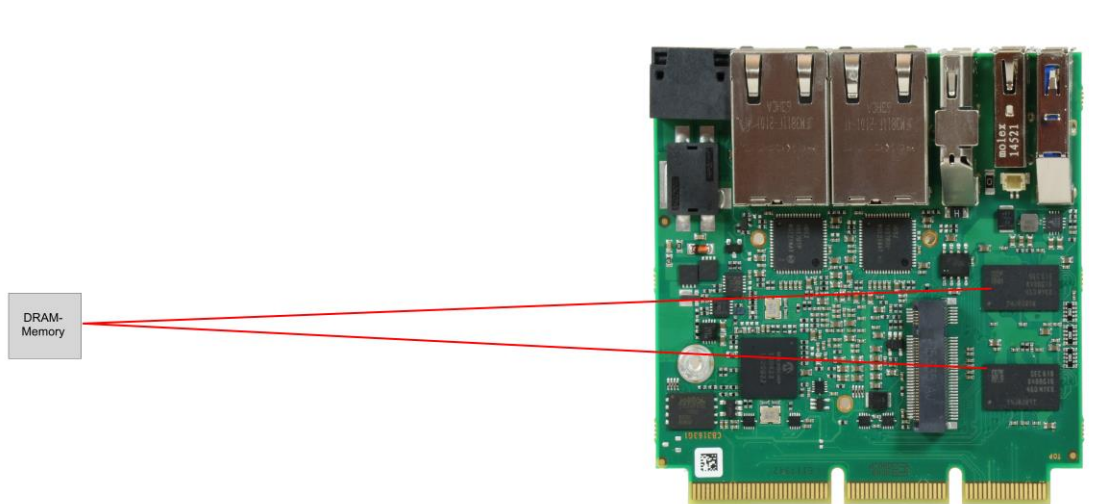

4.3.2 M.2 2242 (Keying B)

The ADLE3800SEC is equipped with a further M.2 socket, in which M.2-2242 cards (keying B) can be inserted. The socket leads SATA signals (up to 3 Gb/s) through, and therefore enables the use of an M.2 SSD card.

| Manufacturer | Description | Mating Connector |
|--------------|------------------|------------------|
| FCI | 10128796-0004RLF | (M.2 card) |

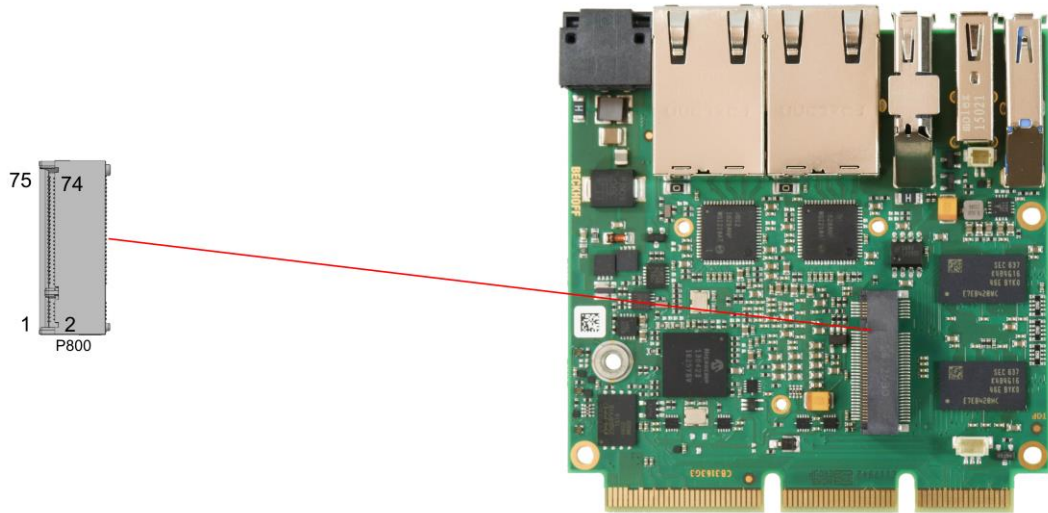

| Description | Name | Pin | | Name | Description |
|----------------------|-----------------------------|-----|----|-----------------------------|--------------------------------|
| Configuration pin | CONFIG_3 | 1 | 2 | 3.3V1 | Standby power supply S3,3V |
| ground | GND1 | 3 | 4 | 3.3V2 | Standby power supply S3,3V |
| ground | GND2 | 5 | 6 | FCPWROFF # | Full Card Power OFF active low |
| USB channel 3 data + | USB_D+ | 7 | 8 | WDISABLE# | (not available) |
| USB channel 3 data - | USB_D- | 9 | 10 | GPIO9 DAS DDS LED1 | (not available) |
| ground | GND3 | 11 | 12 | connector key | |
| connector key | | 13 | 14 | | |
| | | 15 | 16 | | |
| | | 17 | 18 | | |
| | | 19 | 20 | GPIO5 | (not available) |
| Configuration pin | CONFIG_0 | 21 | 22 | GPIO6 | (not available) |
| (not available) | GPIO11 | 23 | 24 | GPIO7 | (not available) |
| (not available) | DPR | 25 | 26 | GPIO10 | (not available) |
| ground | GND4 | 27 | 28 | GPIO8 | (not available) |
| (not available) | PER1# USB3RX# SSICRX# | 29 | 30 | UIM_RST | (not available) |
| (not available) | PER1 USB3RX SSICRX | 31 | 32 | UIM_CLK | (not available) |

| Description | Name | Pin | | Name | Description |
|------------------------|-----------------------------|-----|----|------------|----------------------------|
| ground | GND5 | 33 | 34 | UIM_DATA | (not available) |
| (not available) | PET1# USB3TX# SSICTX# | 35 | 36 | UIM_PWR | (not available) |
| (not available) | PET1 USB3TX SSICTX | 37 | 38 | DEVSLP | (not available) |
| ground | GND6 | 39 | 40 | GPIO0 | (not available) |
| SATA lane 2 receive + | PER0# SATAB | 41 | 42 | GPIO1 | (not available) |
| SATA lane 2 receive - | PER0 SATAB# | 43 | 44 | GPIO2 | (not available) |
| ground | GND7 | 45 | 46 | GPIO3 | (not available) |
| SATA lane 2 transmit - | PET0# SATAA# | 47 | 48 | GPIO4 | (not available) |
| SATA lane 2 transmit + | PET0 SATAA | 49 | 50 | PRST# | PCIe Reset active low |
| ground | GND8 | 51 | 52 | CLKREQ# | (not available) |
| (not available) | REFCLK# | 53 | 54 | PEWAKE# | (not available) |
| (not available) | REFCLK | 55 | 56 | N/C | (not available) |
| ground | GND9 | 57 | 58 | N/C | (not available) |
| (not available) | ANTCTL0 | 59 | 60 | COEX3 | (not available) |
| (not available) | ANTCTL1 | 61 | 62 | COEX2 | (not available) |
| (not available) | ANTCTL2 | 63 | 64 | COEX1 | (not available) |
| (not available) | ANTCTL3 | 65 | 66 | SIM_DETECT | (not available) |
| Powergood | RESET# | 67 | 68 | SUSCLK | system clock |
| Configuration pin | CFG1 | 69 | 70 | 3.3V3 | Standby power supply S3,3V |
| ground | GND10 | 71 | 72 | 3.3V4 | Standby power supply S3,3V |
| ground | GND11 | 73 | 74 | 3.3V5 | Standby power supply S3,3V |
| configuration pin | CFG2 | 75 | | | |

NOTICE

The column 'Name' lists all resources, provided by the chipset. Those resources, which are made available, are listed in the column 'Description'. Items marked with (*) are optional resources. If you use an add-in card, which is not or not fully supported, the BIOS will display an error message.

4.3.3 Display Port

For DisplayPort devices, a suitable standard connector is available.

Additionally, the interface offers HDMI/DVI signaling which can be made available using an adapter. Mating adapters are available, please contact your distributor.

| Manufacturer | Description | Mating Connector |
|--------------|------------------|----------------------------------|
| Foxconn | 3VD21207-H7U0-4H | (Standard DisplayPort connector) |

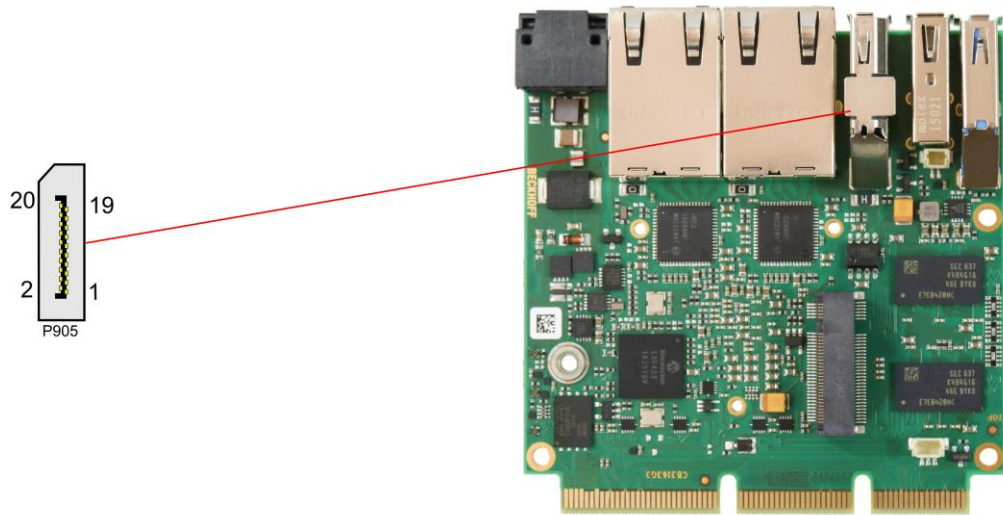

Pinout DisplayPort connector:

| Description | Name | Pin | Name | Description |
|----------------------|---------|-----|------|-------------|
| Displayport Lane 0 + | DPL0 | 1 | 2 | GND |
| Displayport Lane 0 - | DPL0# | 3 | 4 | DPL1 |
| Ground | GND | 5 | 6 | DPL1# |
| Displayport Lane 2 + | DPL2 | 7 | 8 | GND |
| Displayport Lane 2 - | DPL2# | 9 | 10 | DPL3 |
| Ground | GND | 11 | 12 | DPL3# |
| Configuration pin 1 | Config1 | 13 | 14 | Config2 |
| Displayport Aux + | DPAUX | 15 | 16 | GND |
| Displayport Aux - | DPAUX# | 17 | 18 | HPD |
| Ground | GND | 19 | 20 | 3.3V |

NOTICE

Switching to HDMI

By default, the interface offers DisplayPort signals. According to DisplayPort specification 1.1., the ADLE3800SEC will automatically switch to HDMI, when using a level shifter cable.

4.3.4 BAsCon140 Connector

With the BAsCon140 connector the ADLE3800SEC provides a flexible and uncomplicated add-on of additional IO interfaces. The BAsCon140 connector offers up to 8 PCIe lanes, from which 4 can be muxed with SATA2.0 (3G) and the other 4 can be muxed with USB3.0 signals. It also leads through DisplayPort-, HSIC-, SMBus- and 1Wire-signals. All configuration data are saved on the backplane EEPROM. The backplane communicates the data to the board via SMB and therefore enables an uncomplicated and self-configuring IO extension.

Notice current limits as follows: maximum load for S3.3V and 3.3V is 1A. For SVCC and VCC the maximum load is 1.5A.

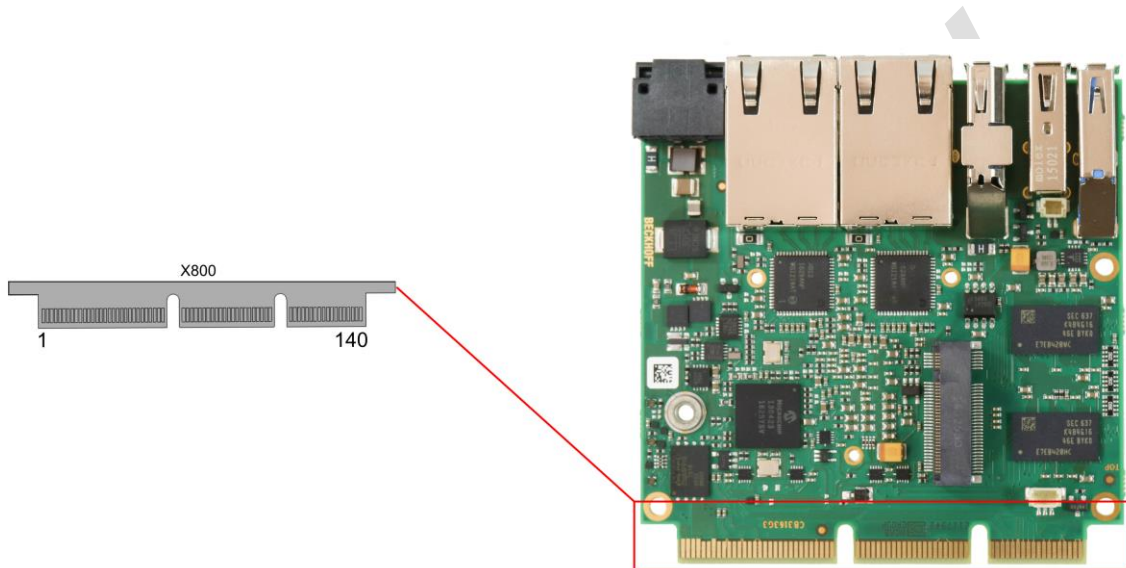

Pinout BAsCon140

| Description | Name | Pin | Pin | Name | Description |
|------------------------|-----------------------|-----|-----|------------------------|---------------------------|
| SUPS output | SUSV OUT1 | 1 | 2 | SUSV IN1 | SUPS input |
| SUPS output | SUSV OUT2 | 3 | 4 | SUSV IN2 | SUPS input |
| VCC | 5V1 | 5 | 6 | GND16 | Ground |
| VCC | 5V2 | 7 | 8 | GND17 | Ground |
| Ground | GND1 | 9 | 10 | 3,3V1 | Power supply 3.3V |
| Ground | GND2 | 11 | 12 | 3,3V2 | Power supply 3.3V |
| SVCC | S5V | 13 | 14 | S3,3V | Standby power supply 3.3V |
| Ground | GND3 | 15 | 16 | GND18 | Ground |
| PCIe Lane 1 transmit + | PE1 TX/ SATA4 TX | 17 | 18 | SATA4 RX/ PE1 RX | PCIe Lane 1 receive + |
| PCIe Lane 1 transmit - | PE1 TX#/ SATA4 TX# | 19 | 20 | SATA4 RX #/ PE1 RX# | PCIe Lane 1 receive - |
| Ground | GND4 | 21 | 22 | GND19 | Ground |
| PCIe Clock Lane 1 + | PECLK1 | 23 | 24 | PECLK2 | PCIe clock Lane 2 + |
| PCIe Clock Lane 1 - | PECLK1# | 25 | 26 | PECLK2# | PCIe clock Lane 2 - |
| Ground | GND5 | 27 | 28 | GND20 | Ground |
| PCIe Lane 2 transmit + | PE2 TX/ SATA3 TX | 29 | 30 | SATA3 RX/ PE2 RX | PCIe Lane 2 Receive + |
| PCIe Lane 2 transmit - | PE2 TX#/ SATA3 TX# | 31 | 32 | SATA3 RX #/ PE2 RX# | PCIe Lane 2 Receive - |

| Description | Name | Pin | | Name | Description |
|--|--------------------------------------|-----|----|--------------------------------------|--|
| Ground | GND6 | 33 | 34 | GND21 | Ground |
| (not available) | PE3-TX/ SATA2-TX | 35 | 36 | SATA2 RX/ PE3 RX | (not available) |
| (not available) | PE3-TX#/ SATA2-TX# | 37 | 38 | SATA2 RX#/ PE3 RX# | (not available) |
| Ground | GND7 | 39 | 40 | GND22 | Ground |
| (not available) | PECLK3 | 41 | 42 | PECLK4 | (not available) |
| (not available) | PECLK3# | 43 | 44 | PECLK4# | (not available) |
| Ground | GND8 | 45 | 46 | GND23 | Ground |
| SATA Lane 2 transmit + | PE4-TX/ SATA1-TX | 47 | 48 | SATA1 RX/ PE4 RX | SATA Lane 2 receive + |
| SATA Lane 2 transmit - | PE4-TX#/ SATA1-TX# | 49 | 50 | SATA1 RX #/ PE4 RX # | SATA Lane 2 receive - |
| Ground | GND9 | 51 | 52 | GND24 | Ground |
| PCIe Clock Enable Lane 1 active low | PCKE1# | 53 | 54 | PCKE2# | PCIe Lane 2 Clock Enable active low |
| (not available) | PCKE3# | 55 | 56 | PCKE4# | (not available) |
| PCIe reset active low | PERST# | 57 | 58 | PEWAKE# | PCIe Wake active low |
| SMBus clock | SMBCLK | 59 | 60 | SMBDAT | SMBus data active high |
| Key | | | | | |
| SMBus alert active low | SMB-Alert# | 61 | 62 | 1Wire | 1-Wire |
| (not available) | PCKE5/OC4 # | 63 | 64 | PCKE6#/ OC3# | (not available) |
| (not available) | PCKE7/OC2 # | 65 | 66 | PCKE8#/ OC1# | USB Overcurrent active low |
| Ground | GND10 | 67 | 68 | GND25 | Ground |
| (not available) | PE5-TX/ USB3-4-TX/ USBC1-TX | 69 | 70 | USBC1 RX/ USB3-4 RX/ PE5 RX | (not available) |
| (not available) | PE5-TX#/ USB3-4-TX#/ USBC1_TX# | 71 | 72 | USBC1 RX#/ USB3-4 RX#/ PE5 RX# | (not available) |
| (not available) | USB2-4 (GND) | 73 | 74 | USB2-3 (GND) | (not available) |
| (not available) | PECLK5/US BC_SBU1 (GND) | 75 | 76 | PECLK6 (GND) | (not available) |
| (not available) | PECLK5#/ USBC-SBU2 (GND) | 77 | 78 | PECLK6# (GND) | (not available) |
| (not available) | USB2-4# (GND) | 79 | 80 | USB2-3 (GND) | (not available) |
| (not available) | PE6-TX/ USB3-3-TX/ USBC2-TX | 81 | 82 | USBC2 RX/ USB3-3 RX/ PE5 RX | (not available) |
| (not available) | PE6-TX#/ USB3-3-TX#/ USBC2-TX# | 83 | 84 | USBC2 RX#/ USB3-3 RX#/ PE5 RX# | (not available) |
| Ground | GND11 | 85 | 86 | GND26 | Ground |

| Description | Name | Pin | | Name | Description |
|--------------------------------------|-------------------------------------|-----|-----|-------------------------------------|------------------------|
| (not available) | PE7-TX/ USB3-2-TX/ SSIC-TX | 87 | 88 | SSIC RX/ USB3-2 RX/ PE7 RX | (not available) |
| (not available) | PE7-TX#/ USB3-2-TX#/ SSIC-TX# | 89 | 90 | SSIC RX#/ USB3-2 RX#/ PE6 RX# | (not available) |
| USB 2.0 channel 3 + | USB2-2 (GND) | 91 | 92 | USB2-1 (GND) | USB 2.0 channel 4 + |
| Ground | PECLK7 (GND) | 93 | 94 | PECLK8 (GND) | Ground |
| Ground | PECLK7# (GND) | 95 | 96 | PECLK8# (GND) | Ground |
| USB 2.0 channel 3 - | USB2-2# (GND) | 97 | 98 | USB2-1# (GND) | USB 2.0 channel 4 - |
| (not available) | PE8-TX/ USB3-1-TX | 99 | 100 | USB3-1 RX/ PE8 RX | (not available) |
| (not available) | PE8-TX#/ USB3-1-TX# | 101 | 102 | USB3-1 RX#/ PE8 RX# | (not available) |
| Ground | GND12 | 103 | 104 | GND27 | Ground |
| Key | | | | | |
| SATA GP1 | GPIO1/ SATAGP1 | 105 | 106 | SATAGP2/ GPIO2 | (not available) |
| (not available) | N/A | 107 | 108 | USB-CC2/ SATAGP4/ GPIO4 | (not available) |
| TwinCAT LED red | GPIO5/ TCLEDR | 109 | 110 | GPIO6/ TCLEDG | TwinCAT LED green |
| TwinCAT LED blue | GPIO7/ TCLEDB | 111 | 112 | GPIO8 | (not available) |
| SATA LED active low | SATA-LED | 113 | 114 | USBPWREN | USB Power Enable |
| RTC-Battery | BATT | 115 | 116 | PWRFAIL | SUSV |
| Power Management Event active low | PME# | 117 | 118 | PWRGOOD | Powergood |
| Powerbutton active low | PWRBTN# | 119 | 120 | MRST# | Resetbutton active low |
| PSON | PSON | 121 | 122 | ATXPWRGD | ATX Powergood |
| Ground | GND13 | 123 | 124 | GND28 | Ground |
| DisplayPort + / DVI - | DP/DVI# | 125 | 126 | DDCC/ DPAUX | DisplayPort Aux + |
| DisplayPort Hot Plug Detect | DHPD | 127 | 128 | DDCD/ DPAUX# | DisplayPort Aux - |
| Ground | GND14 | 129 | 130 | GND29 | Ground |
| DisplayPort Lane 0 + | DPL0 | 131 | 132 | DPL1 | DisplayPort Lane 1 + |
| DisplayPort Lane 0 - | DPL0# | 133 | 134 | DPL1# | DisplayPort Lane 1 - |
| Ground | GND | 135 | 136 | GND30 | Ground |
| DisplayPort Lane 2 + | DPL2 | 137 | 138 | DPL3 | DisplayPort 3 + |
| DisplayPort Lane 2 - | DPL2# | 139 | 140 | DPL3# | DisplayPort 3 - |

NOTICE

The column 'Name' lists all resources, provided by the chipset. Those resources, which are made available, are listed in the column 'Description'. Items marked with (*) are optional resources. If you use an add-in card, which is not or not fully supported, the BIOS will display an error message.

4.3.5 External Battery

In order to supply the ADLE3800SEC in case of a powerfail, it can be plugged into an external RTC battery via a 2pin connector. The maximum battery voltage is 3.3V.

| Manufacturer | Description | Mating Connector |
|--------------|-----------------------|---------------------|
| JST | BM02B-SRSS-TB(LF)(SN) | e.g. JST455-1392-ND |

NOTICE

UL Conformity: The board already implements all required technical measures for UL conformity. Connect the battery directly. There are no further technical measures required!

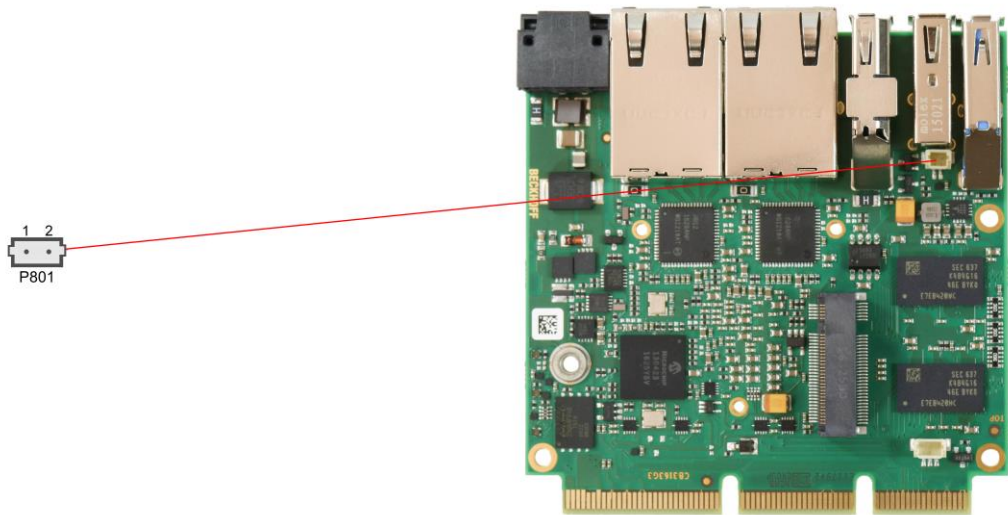

NOTICE

Synchronicity of RTC: The RTC quartz is sensitive to thermal fluctuation. Therefore the synchronicity can only be achieved with sufficient cooling!

| Pin | Name | Description |
|-----|------|------------------|
| 1 | BATT | battery 3.3 volt |
| 2 | GND | ground |

4.3.6 FAN Connector

A 3-pin connector is available for controlling and monitoring an external fan (5 volt). For the monitoring the fan must provide a corresponding speed signal.

| Manufacturer | Description | Mating Connector |
|--------------|-----------------------|--------------------|
| JST | BM03B-SRSS-TB(LF)(SN) | z.B. JST SHR-03V-S |

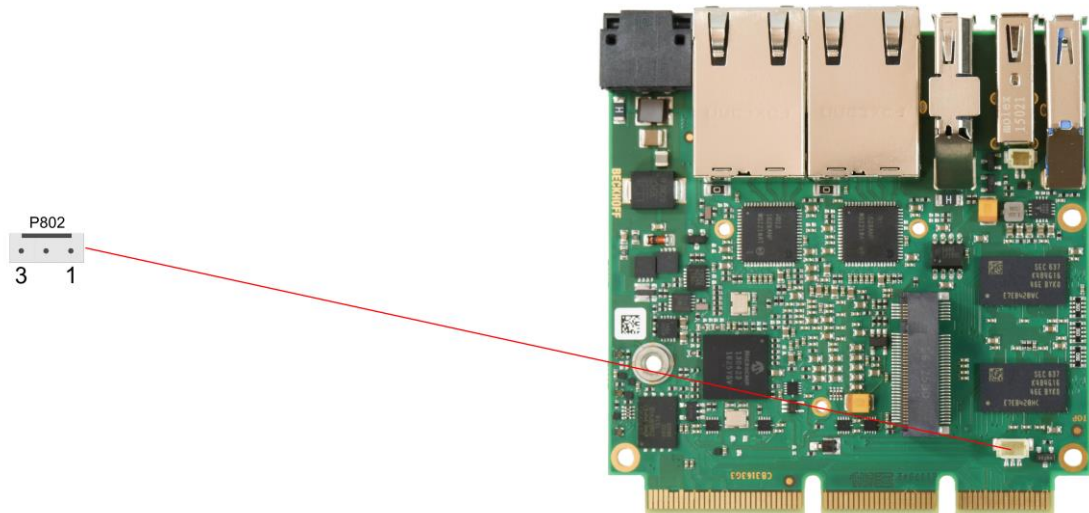

| Pin | Name | Description |
|-----|---------|---------------------------|
| 1 | FANON | Control signal FAN |
| 2 | VCC | Power supply 5V regulated |
| 3 | FANCTRL | Monitoring signal FAN |

4.4 LED Signaling

4.4.1 RGB LED

The ADLE3800SEC has a tricolor LED, which signals status messages by using different colors and flash intervals.

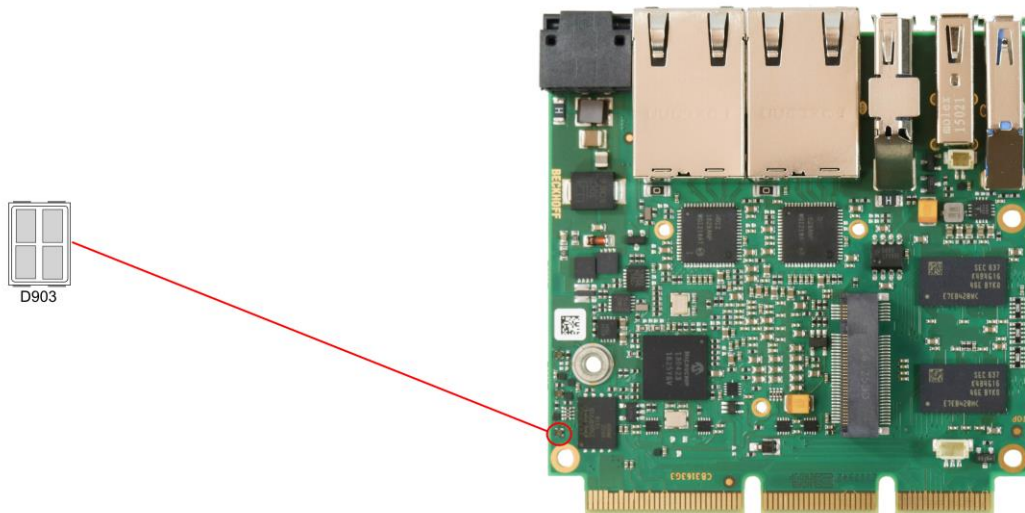

| Color | Interval | | Meaning |
|--------------|-----------------|--|---|
| non | solid | | Invalid system state |
| White | once | | Powerfail |
| Cyan | solid | | Reserved |
| Magenta | solid | | SUPS active |
| Blue | solid | | Reserved |
| Yellow | solid | | S5 state |
| Green | solid | | S0 state |
| Red | solid | | Reset/Start |
| Green/Yellow | flashing | | Bootloader operates normal |
| Red/Yellow | flashing | | Bootloader starting (running starting sequence) |
| Yellow | flashing (6s) | | S4 state |
| Yellow | flashing (3s) | | S3 state |
| Magenta | flashing (0,5s) | | SUPS test of capacity |
| Red/Magenta | flashing | | Bootloader: checksum error at I2C transmission |

NOTICE

The status codes can be customized, e.g. for TwinCAT LED. The system colors can be altered via SMB command. The alteration remains until the following restart or reset of the system. Additionally, a flashing white LED light displays the change of default colors.

4.4.2 Harddisk-LED

An additional RGB LED signals the harddisk activity.

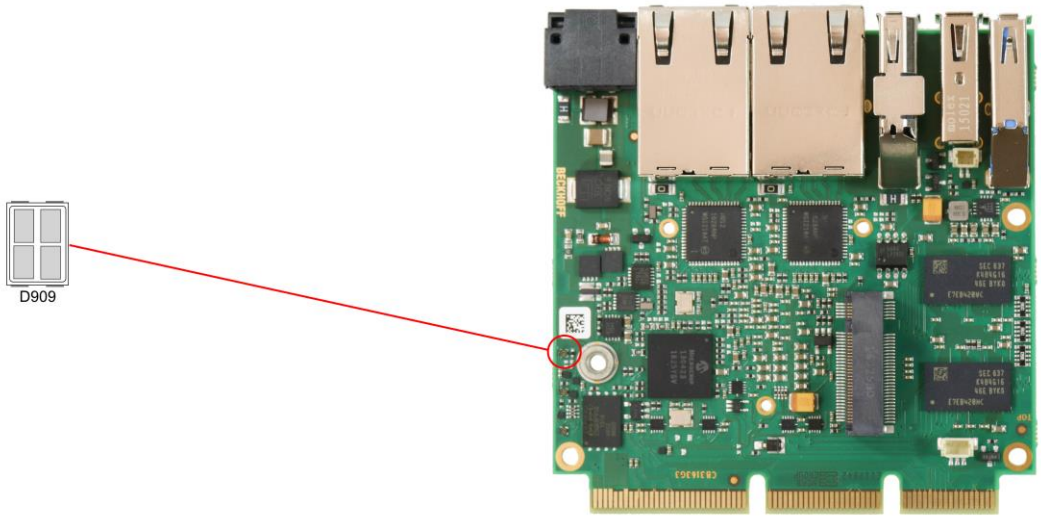



| Colours | Interval | State |
|---------|---|--------|
| Red | intermittent | active |

4.4.3 TwinCAT-LED

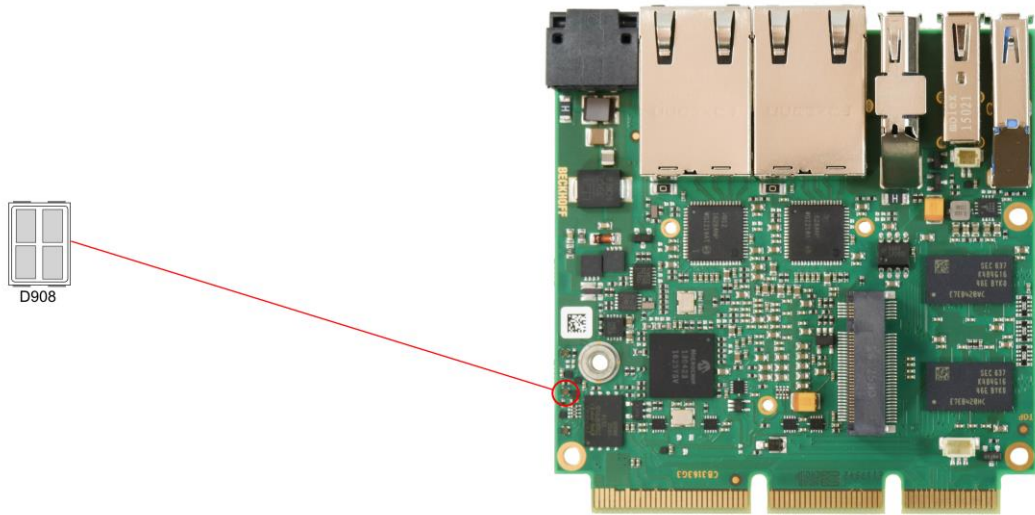
The TwinCAT activity is signaled through a further RGB LED:



| Colour | Interval | | State |
|--------|-----------|---|---------------------|
| Green | permanent |  | TwinCAT Run Mode |
| Blue | permanent |  | TwinCAT Config Mode |
| Red | permanent |  | TwinCAT Stop |

5 BIOS Settings

5.1 General Remarks

In each setup page, standard values for all setup entries can be loaded. Previously saved settings are loaded by pressing F2 and factory defaults are loaded with F3. Both F2 and F3, and also F4 ("Save & Exit") always affect the whole set of setup entries.

Setup entries starting with a „▶" sign represent submenus. Navigation between entries is done using the arrow keys on the keyboard, with the <Enter> key being used to select an entry, which either opens up a dialog box or opens a whole new submenu of setup entries.

Each setup entry has a short help text associated with it. This is displayed in the upper right hand corner of the screen.

NOTICE

BIOS features and setup options are subject to change without notice. The settings displayed in the screenshots on the following pages are meant to be examples only. They do not represent the recommended settings or the default settings. Determination of the appropriate settings is dependent upon the particular application scenario in which the board is used.

5.2 Main

Aptio Setup Utility - Copyright (C) 2016 American Megatrends, Inc.
 MAIN Advanced Chipset Security Boot Save & Exit

| | |
|--|--|
| <pre> Board Information Board ADLE3800SEC Revision f Bios Version 0.08 CPU Configuration Microcode Patch 321 BayTrail SoC B2 Stepping Memory Information Total Memory 8192 MB (LPDDR3) System Date [Sun 12/05/2014] System Time [00:47:04] </pre> | <pre> Set the Date. Use Tab to switch between Data elements. ----- ->: Select Screen ↑↓: Select Item Enter: Select +/-: Change Opt. F1: General Help F2: Previous Values F3: Optimized Defaults F4: Save & Exit ESC: Exit </pre> |
|--|--|

Version 2.17.1249. Copyright (C) 2016 American Megatrends, Inc.

- ✓ **Board**
Options: none
- ✓ **Revision**
Options: none
- ✓ **Bios Version**
Options: none
- ✓ **Microcode Patch**
Options: none
- ✓ **BayTrail SoC**
Options: none
- ✓ **Total Memory**
Options: none
- ✓ **System Date**
Options: The system date can be adjusted here.
- ✓ **System Time**
Options: The system time can be adjusted here.

5.3 Advanced

Aptio Setup Utility - Copyright (C) 2016 American Megatrends, Inc.
 Main ADVANCED Chipset Security Boot Save & Exit

| | |
|--|--|
| <pre> Power-Supply Type [ATX] ▶ PCI RT32 Service [Disabled] ▶ ACPI Settings ▶ Hardware Monitor ▶ CPU Configuration ▶ PPM Configuration ▶ SATA Configuration ▶ Miscellaneous Configuration ▶ Network Stack Configuration ▶ Power Controller Options ▶ CSM Configuration ▶ NVMe Configuration ▶ SDIO Configuration ▶ USB Configuration ▶ Intel(R) I210 Gigabit Network Connection - 00:01:05:... ▶ Intel(R) I210 Gigabit Network Connection - 00:01:05:... ▶ Intel(R) I210 Gigabit Network Connection - 00:01:05:... </pre> | <pre> Select the Type of the Power Supply: AT/ATX ----- ←-: Select Screen ↑↓: Select Item Enter: Select +/-: Change Opt. F1: General Help F2: Previous Values F3: Optimized Defaults F4: Save & Exit ESC: Exit </pre> |
|--|--|

Version 2.17.1249. Copyright (C) 2016 American Megatrends, Inc.

- ✓ **Power-Supply Type**
Options: ATX / AT
- ✓ **PCI RT32 Service**
Options: Enabled / Disabled
- ✓ **ACPI Settings**
Sub menu: see "ACPI Settings" (page 35)
- ✓ **H/W Monitor**
Sub menu: see "H/W Monitor" (page 36)
- ✓ **CPU Configuration**
Sub menu: see "CPU Configuration" (page 37)
- ✓ **PPM Configuration**
Sub menu: see "PPM Configuration" (page 40)
- ✓ **SATA Configuration**
Sub menu: see "SATA Configuration" (page 41)
- ✓ **Miscellaneous Configuration**
Sub menu: see "Miscellaneous Configuration" (page 42)
- ✓ **Network Stack**
Sub menu: see "Network Stack" (page 43)
- ✓ **Power Controller Options**
Sub menu: see "Power Controller Options" (page 44)
- ✓ **CSM Configuration**
Sub menu: see "CSM Configuration" (page 45)

- ✓ **NVMe Configuration**
Sub menu: see "Advanced-Menü-NVMe Configuration" (page 46)
- ✓ **SDIO Configuration**
Sub menu: see "SDIO Configuration" (page 47)
- ✓ **USB Configuration**
Sub menu: see "USB Configuration" (page 48)
- ✓ **Security Configuration**
Sub menu: see "Security Configuration" (page 49)
- ✓ **Intel(R) Gigabit Network Connection**
Sub menu: see "Intel(R) I210 Gigabit Network Connection" (page 50)
- ✓ **Driver Health**
Sub menu: see "Driver Health" (page 52)

5.3.1 ACPI Settings

Aptio Setup Utility - Copyright (C) 2016 American Megatrends, Inc.
Advanced

| | | |
|--------------------------------|--------------------|---|
| ACPI Settings | | Enables or Disables BIOS ACPI Auto Configuration. |
| Enable ACPI Auto Configuration | [Disabled] | |
| Enable Hibernation | [Enabled] | ←: Select Screen ↑↓: Select Item Enter: Select +/-: Change Opt. F1: General Help F2: Previous Values F3: Optimized Defaults F4: Save & Exit ESC: Exit |
| ACPI Sleep State | [Suspend Disabled] | |
| Lock Legacy Resources | [Disabled] | |

Version 2.17.1249. Copyright (C) 2016 American Megatrends, Inc.

- ✓ **Enable ACPI Auto Configuration**
Options: Enabled / Disabled
- ✓ **Enable Hibernation**
Options: Enabled / Disabled
- ✓ **ACPI Sleep State**
Options: Suspend Disabled / S1 (CPU Stop Clock)
- ✓ **Lock Legacy Resources**
Options: Enabled / Disabled

5.3.2 H/W Monitor

Aptio Setup Utility - Copyright (C) 2016 American Megatrends, Inc.
Advanced

| | |
|--|--|
| <p>Pc Health Status</p> <p>CPU dig. : +44 'C MB Temp : +44 'C PwrCtrlVCC : +5.20 V</p> | |
| | <p>←: Select Screen ↑↓: Select Item Enter: Select +/-: Change Opt. F1: General Help F2: Previous Values F3: Optimized Defaults F4: Save & Exit ESC: Exit</p> |

Version 2.17.1249. Copyright (C) 2016 American Megatrends, Inc.

- ✓ **CPU dig.**
Options: none
- ✓ **MB Temp**
Options: none
- ✓ **PwrCtrlVCC**
Options: none

5.3.3 CPU Configuration

Aptio Setup Utility - Copyright (C) 2016 American Megatrends, Inc.
Advanced

| CPU Configuration | Socket specific CPU Information |
|--|--|
| <ul style="list-style-type: none"> ▶ Socket 0 CPU Information ▶ CPU Thermal Configuration <p>CPU Speed 1467 MHz 64-bit Supported</p> <p>Limit CPUID Maximum [Disabled] Execute Disable Bit [Enabled] Intel Virtualization Technology [Enabled]</p> | <p>←: Select Screen ↑↓: Select Item Enter: Select +/-: Change Opt. F1: General Help F2: Previous Values F3: Optimized Defaults F4: Save & Exit ESC: Exit</p> |

Version 2.17.1249. Copyright (C) 2016 American Megatrends, Inc.

- ✓ **Socket 0 CPU Information**
Sub menu: see "Socket CPU Information" (page 38)
- ✓ **CPU Thermal Configuration**
Sub menu: see "CPU Thermal Configuration" (page 39)
- ✓ **CPU Speed**
Options: none
- ✓ **64-bit**
Options: none
- ✓ **Limit CPUID Maximum**
Options: Enabled / Disabled
- ✓ **Execute Disable Bit**
Options: Enabled / Disabled
- ✓ **Intel Virtualization Technology**
Options: Enabled / Disabled

5.3.3.1 Socket CPU Information

Aptio Setup Utility - Copyright (C) 2016 American Megatrends, Inc.
Advanced

| Socket 0 CPU Information | |
|---------------------------------------|---------------|
| Intel(R) Atom(TM) CPU E3845 @ 1.91GHz | |
| CPU Signature | 30679 |
| Microcode Patch | 901 |
| Max CPU Speed | 1910 MHz |
| Min CPU Speed | 500 MHz |
| Processor Cores | 4 |
| Intel HT Technology | Not Supported |
| Intel VT-x Technology | Supported |
| L1 Data Cache | 24 kB x 4 |
| L1 Code Cache | 32 x kB 4 |
| L2 Cache | 1024 kB x 2 |
| L3 Cache | Not Present |

| |
|---|
| ←: Select Screen ↑↓: Select Item Enter: Select +/-: Change Opt. F1: General Help F2: Previous Values F3: Optimized Defaults F4: Save & Exit ESC: Exit |
|---|

Version 2.17.1249. Copyright (C) 2016 American Megatrends, Inc.

- ✓ **CPU Signature**
Options: none
- ✓ **Microcode Patch**
Options: none
- ✓ **Max CPU Speed**
Options: none
- ✓ **Min CPU Speed**
Options: none
- ✓ **Processor Cores**
Options: none
- ✓ **Intel HT Technology**
Options: none
- ✓ **Intel VT-x Technology**
Options: none
- ✓ **L1 Data Cache**
Options: none
- ✓ **L1 Code Cache**
Options: none
- ✓ **L2 Cache**
Options: none
- ✓ **L3 Cache**
Options: none

5.3.3.2 CPU Thermal Configuration

Aptio Setup Utility - Copyright (C) 2016 American Megatrends, Inc.
Advanced

| | |
|---|--|
| CPU Thermal Configuration DTS [Disabled] | Enabled/Disable Digital Thermal Sensor. ←: Select Screen ↑↓: Select Item Enter: Select +/-: Change Opt. F1: General Help F2: Previous Values F3: Optimized Defaults F4: Save & Exit ESC: Exit |
|---|--|

Version 2.17.1249. Copyright (C) 2016 American Megatrends, Inc.

- ✓ **DTS**
Options: Enabled / Disabled

5.3.4 PPM Configuration

Aptio Setup Utility - Copyright (C) 2016 American Megatrends, Inc.
Advanced

| | | |
|--------------------|------------|--|
| PPM Configuration | | Enable/Disable CPU C state report to OS |
| CPU C state Report | [Enabled] | |
| Max CPU C-state | [C7] | |
| Soix | [Disabled] | |
| | | ←: Select Screen ↑: Select Item Enter: Select +/-: Change Opt. F1: General Help F2: Previous Values F3: Optimized Defaults F4: Save & Exit ESC: Exit |

Version 2.17.1249. Copyright (C) 2016 American Megatrends, Inc.

- ✓ **CPU C state Report**
Options: Disabled / Enabled
- ✓ **Max CPU C-state**
Options: C7 / C6 / C1
- ✓ **S0ix**
Options: Disabled / Enabled

5.3.5 SATA Configuration

Aptio Setup Utility - Copyright (C) 2016 American Megatrends, Inc.
Advanced

| | | |
|--------------------|-------------|---|
| SATA Configuration | | Enable or disable SATA Device. |
| Serial-ATA (SATA) | [Enabled] | |
| SATA Test Mode | [Disabled] | |
| SATA Speed Support | [Gen2] | |
| SATA ODD Port | [No ODD] | |
| SATA Mode | [AHCI Mode] | |
| Serial-ATA Port 0 | [Enabled] | |
| SATA Port0 HotPlug | [Disabled] | |
| Serial-ATA Port 1 | [Enabled] | |
| SATA Port1 HotPlug | [Disabled] | |
| SATA Port0 | Not Present | |
| SATA Port1 | Not Present | |
| | | ←: Select Screen ↑↓: Select Item n Enter: Select +/-: Change Opt. F1: General Help F2: Previous Values F3: Optimized Defaults F4: Save & Exit ESC: Exit |

Version 2.17.1249. Copyright (C) 2016 American Megatrends, Inc.

- ✓ **Serial-ATA (SATA)**
Options: Enabled / Disabled
- ✓ **SATA Test Mode**
Options: Enabled / Disabled
- ✓ **SATA Speed Support**
Options: Gen1 / Gen2
- ✓ **SATA ODD Port**
Options: Port0 ODD / Port1 ODD / No ODD
- ✓ **SATA Mode**
Options: IDE Mode / AHCI Mode
- ✓ **Serial-ATA Port X**
Options: Enabled / Disabled

5.3.6 Miscellaneous Configuration

Aptio Setup Utility - Copyright (C) 2016 American Megatrends, Inc.
Advanced

| | |
|---|--|
| Miscellaneous Configuration High Precision Timer [Enabled] Boot Timer with HPET Timer [Disabled] PCI Express Dynamic Clock Gating [Disabled] OS Selection [Windows 7] | Enable or Disable the High Precision Event Timer |
| | ←: Select Screen ↑: Select Item Enter: Select +/-: Change Opt. F1: General Help F2: Previous Values F3: Optimized Defaults F4: Save & Exit ESC: Exit |

Version 2.17.1249. Copyright (C) 2016 American Megatrends, Inc.

- ✓ **High Precision Timer**
Options: Disabled / Enabled
- ✓ **Boot Timer with HPET Timer**
Options: Enabled / Disabled
- ✓ **PCI Express Dynamic Clock Gating**
Options: Enabled / Disabled
- ✓ **OS Selection**
Options: Windows 8.X / Windows 7

5.3.7 Network Stack

Aptio Setup Utility - Copyright (C) 2016 American Megatrends, Inc.
Advanced

| | | |
|--------------------|-----------|---|
| Network stack | [Enabled] | Enable/Disable UEFI network stack |
| IPv4 PXE Support | [Enabled] | |
| IPv6 PXE Support | [Enabled] | |
| PXE boot wait time | 0 | |
| Media detect count | 1 | |
| | | →: Select Screen ↑↓: Select Item Enter: Select +/-: Change Opt. F1: General Help F2: Previous Values F3: Optimized Defaults F4: Save & Exit ESC: Exit |

Version 2.17.1249. Copyright (C) 2016 American Megatrends, Inc.

- ✓ **Network stack**
Options: Disabled / Enabled
- ✓ **IPv4 PXE Support**
Options: Disabled / Enabled
- ✓ **IPv6 PXE Support**
Options: Disabled / Enabled
- ✓ **PXE boot wait time**
Options: 0..5
- ✓ **Media detect count**
Options: none

5.3.8 Power Controller Options

Aptio Setup Utility - Copyright (C) 2016 American Megatrends, Inc.
Advanced

| | |
|--|---|
| <pre> Bootloader Version 1.00-23 Firmware Version 1.00-43 Mainboard Serial No 0948251130007 Mainboard Prod. Date (Week.Year) 14.14 Mainboard BootCount 114 Mainboard Operation Time 10470min (17h) Voltage (Min/Max) 3.10V / 4.80V Temperature (Min/Max) 24'C /59'C </pre> | <p>Select Power line for external USB devices, if powered-down</p> <hr/> <pre> ←: Select Screen ↑↓: Select Item Enter: Select +/-: Change Opt. F1: General Help F2: Previous Values F3: Optimized Defaults F4: Save & Exit ESC: Exit </pre> |
|--|---|

Version 2.17.1249. Copyright (C) 2016 American Megatrends, Inc.

- ✓ **Bootloader Version**
Options: none
- ✓ **Firmware Version**
Options: none
- ✓ **Mainboard Serial No**
Options: none
- ✓ **Mainboard Prod. Date (Week.Year)**
Options: none
- ✓ **Mainboard Boot Count**
Options: none
- ✓ **Mainboard Operation Time**
Options: none
- ✓ **Voltage (Min/Max)**
Options: none
- ✓ **Temperature (Min/Max)**
Options: none

5.3.9 CSM Configuration

Aptio Setup Utility - Copyright (C) 2016 American Megatrends, Inc.
Advanced

| | | |
|--|-------------------|-----------------------------|
| Compatibility Support Module Configuration | | Enable/Disable CSM Support. |
| CSM Support | [Enabled] | |
| CSM16 Module Version | 07.76 | |
| GateA20 Active | [Upon Request] | |
| Option ROM Messages | [Force BIOS] | |
| Boot option filter | [UEFI and Legacy] | |
| Option ROM execution order | | |
| Network | [UEFI only] | ←: Select Screen |
| Storage | [UEFI only] | ↑↓: Select Item |
| Video | [Legacy only] | Enter: Select |
| Other PCI devices | [UEFI only] | +/-: Change Opt. |
| | | F1: General Help |
| | | F2: Previous Values |
| | | F3: Optimized Defaults |
| | | F4: Save & Exit |
| | | ESC: Exit |

Version 2.17.1249. Copyright (C) 2016 American Megatrends, Inc.

- ✓ **CSM Support**
Options: Disabled / Enabled
- ✓ **CSM16 Module Version**
Options: none
- ✓ **GateA20 Active**
Options: Upon Request / Always
- ✓ **Option ROM Messages**
Options: Force BIOS / Keep Current
- ✓ **Boot option filter**
Options: UEFI and Legacy / Legacy only / UEFI only
- ✓ **Network**
Options: Do not launch / UEFI only / Legacy only
- ✓ **Storage**
Options: Do not launch / UEFI only / Legacy only
- ✓ **Video**
Options: Do not launch / UEFI only / Legacy only
- ✓ **Other PCI devices**
Options: Do not launch / UEFI / Legacy

5.3.10 Advanced-Menü-NVMe Configuration

Aptio Setup Utility - Copyright (C) 2016 American Megatrends, Inc.
Advanced

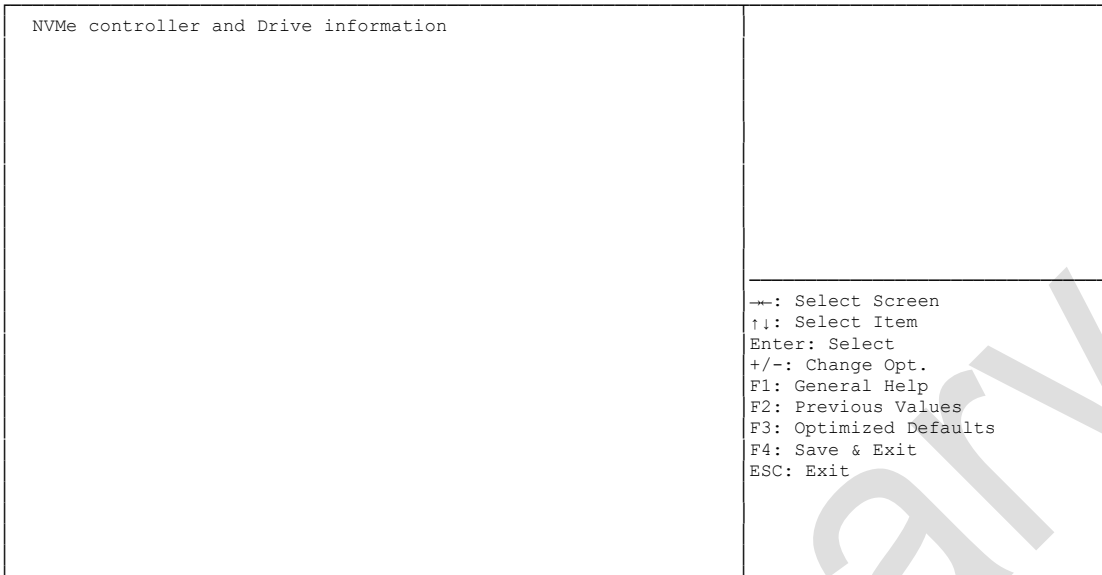

Version 2.17.1249. Copyright (C) 2016 American Megatrends, Inc.

- ✓ **NVMe controller and Drive information**
Options: none

5.3.11 SDIO Configuration

Aptio Setup Utility - Copyright (C) 2016 American Megatrends, Inc.
Advanced

| | |
|--|---|
| <p>SDIO Configuration</p> <p>SDIO Access Mode [AUTO]</p> | <p>Auto Option: Access SD device in DMA mode if controller supports it, otherwise in PIO mode. DMA Option: Access SD device in DMA mode. PIO Option: Access SD device in PIO mode.</p> <hr/> <p>←: Select Screen ↑↓: Select Item Enter: Select +/-: Change Opt. F1: General Help F2: Previous Values F3: Optimized Defaults F4: Save & Exit ESC: Exit</p> |
|--|---|

Version 2.17.1249. Copyright (C) 2016 American Megatrends, Inc.

- ✓ **SDIO Access Mode**
Options: Auto / DMA / PIO

5.3.12 USB Configuration

Aptio Setup Utility - Copyright (C) 2016 American Megatrends, Inc.
Advanced

| | | |
|------------------------------------|------------|---|
| USB Configuration | | Enables Legacy USB support. AUTO option disables legacy support if no USB devices are connected. DISABLE option will keep USB devices available only for EFI applications. |
| USB Module Version | 10 | |
| USB Devices: | | |
| 1 Keyboard, 2 Hubs | | |
| Legacy USB Support | [Enabled] | |
| XHCI Hand-off | [Enabled] | |
| EHCI Hand-off | [Disabled] | |
| USB Mass Storage Driver Support | [Enabled] | |
| Port 60/64 Emulation | [Enabled] | |
| USB hardware delays and time-outs: | | |
| USB transfer time-out | [20 sec] | |
| Device reset time-out | [20 sec] | |
| Device power-up delay | [Manual] | |
| Device power-up delay in seconds | 5 | |
| | | ←: Select Screen ↑↓: Select Item Enter: Select +/-: Change Opt. F1: General Help F2: Previous Values F3: Optimized Defaults F4: Save & Exit ESC: Exit |

Version 2.17.1249. Copyright (C) 2016 American Megatrends, Inc.

- ✓ **USB Devices**
Options: none
- ✓ **Legacy USB Support**
Options: Enabled / Disabled / Auto
- ✓ **XHCI Hand-off**
Options: Enabled / Disabled
- ✓ **EHCI Hand-off**
Options: Enabled / Disabled
- ✓ **Mass Storage Driver Support**
Options: Disabled / Enabled
- ✓ **USB transfer time-out**
Options: 5 sec / 10 sec / 20 sec
- ✓ **Device reset time-out**
Options: 10 sec / 20 sec / 30 sec / 40 sec
- ✓ **Device power-up delay**
Options: Auto / Manual
- ✓ **Device power-up delay in seconds**
Options: 1..40

5.3.13 Security Configuration

Aptio Setup Utility - Copyright (C) 2016 American Megatrends, Inc.
Advanced

| | |
|---|---|
| Intel(R) TXE Configuration TXE [Enabled] TXE HMRFP0 [Disabled] TXE Firmware Update [Enabled] TXE EOP Message [Enabled] TXE Unconfiguration Perform | Send EOP Message Before Enter OS ←: Select Screen ↑↓: Select Item Enter: Select +/-: Change Opt. F1: General Help F2: Previous Values F3: Optimized Defaults F4: Save & Exit ESC: Exit |
|---|---|

Version 2.17.1249. Copyright (C) 2016 American Megatrends, Inc.

- ✓ **TXE**
Options: Enabled / Disabled
- ✓ **TXE HMRFP0**
Options: Enabled / Disabled
- ✓ **TXE Firmware Update**
Options: Enabled / Disabled
- ✓ **TXE EOP Message**
Options: Enabled / Disabled
- ✓ **TXE Unconfiguration Perform**
Options: none

5.3.14 Intel(R) I210 Gigabit Network Connection

Aptio Setup Utility - Copyright (C) 2016 American Megatrends, Inc.
Advanced

| | | |
|--|--|---|
| <p>► NIC Configuration</p> <p>Blink LEDs 0</p> <p>UEFI Driver Intel(R) PRO/1000 5.7.06</p> <p>Adapter PBA: FFFFFFFF-0FF</p> <p>Device Name Intel(R) I210 Gigabit N</p> <p>Chip Type Intel i210</p> <p>PCI Device ID 153A</p> <p>PCI Address 01:00:00</p> <p>Link Status [Disconnected]</p> <p>MAC Address 00:01:05:24:7D:2E</p> <p>Virtual MAC Address 00:01:05:24:7D:2E</p> | | <p>Click to configure the network device port.</p> <hr/> <p>←: Select Screen ↑↓: Select Item Enter: Select +/-: Change Opt. F1: General Help F2: Previous Values F3: Optimized Defaults F4: Save & Exit ESC: Exit</p> |
|--|--|---|

Version 2.17.1249. Copyright (C) 2016 American Megatrends, Inc.

✓ **NIC Configuration**

Sub menu: see "NIC Configuration" (page 51)

✓ **Blink LEDs**

Options: none

✓ **UEFI Driver**

Options: none

✓ **Adapter PBA**

Options: none

✓ **Device Name**

Options: none

✓ **Chip Type**

Options: none

✓ **PCI Device ID**

Options: none

✓ **PCI Address**

Options: none

✓ **Link Status**

Options: none

✓ **MAC Address**

Options: none

✓ **Virtual MAC Address**

Options: none

5.3.14.1 NIC Configuration

Aptio Setup Utility - Copyright (C) 2016 American Megatrends, Inc.
Advanced

| | | |
|--|-------------------------|---|
| Link Speed Wake On LAN | [Auto Neg] [Enabled] | Specifies the port speed used for the selected boot protocol. |
| ←: Select Screen ↑: Select Item Enter: Select +/-: Change Opt. F1: General Help F2: Previous Values F3: Optimized Defaults F4: Save & Exit ESC: Exit | | |

Version 2.17.1249. Copyright (C) 2016 American Megatrends, Inc.

- ✓ **Link Speed**
Options: Auto Negotiated / 10Mbps Half / 10Mbps full / 100Mbps Half / 100Mbps Full
- ✓ **Wake On LAN**
Options: Enabled / Disabled

5.3.15 Driver Health

Aptio Setup Utility - Copyright (C) 2016 American Megatrends, Inc.
Advanced

| | |
|---|---|
| ▶ Intel(R) PRO/1000 5.7.06 PCI-E Healthy | Provides Health Status for the Drivers/Controllers ←: Select Screen ↑↓: Select Item Enter: Select +/-: Change Opt. F1: General Help F2: Previous Values F3: Optimized Defaults F4: Save & Exit ESC: Exit |
|---|---|

Version 2.17.1249. Copyright (C) 2016 American Megatrends, Inc.

- ✓ **Intel(R) PRO/1000 5.7.06 PCI-E**
Sub menu: see "Intel(R) PRO/1000 PCI-E" (page 53)

5.3.15.1 Intel(R) PRO/1000 PCI-E

Aptio Setup Utility - Copyright (C) 2016 American Megatrends, Inc.
Advanced

| | |
|---|--|
| Controller b7c95c18 Child 0 Healthy Intel(R) I210 Gigabit Network Connection Healthy Controller b7c95718 Child 0 Healthy Intel(R) I210 Gigabit Network Connection Healthy Controller b7c95318 Child 0 Healthy Intel(R) I210 Gigabit Network Connection Healthy | Provides Health Status for the Drivers/Controllers |
| ←: Select Screen ↑↓: Select Item Enter: Select +/-: Change Opt. F1: General Help F2: Previous Values F3: Optimized Defaults F4: Save & Exit ESC: Exit | |

Version 2.17.1249. Copyright (C) 2016 American Megatrends, Inc.

- ✓ **Controller x Child n**
Options: none

5.4 Chipset

Aptio Setup Utility - Copyright (C) 2016 American Megatrends, Inc.

Main Advanced CHIPSET Boot Security Save & Exit

| | |
|--|--|
| <pre> ▶ North Bridge ▶ South Bridge </pre> | <pre> North Bridge Parameters ----- ←: Select Screen ↑↓: Select Item Enter: Select +/-: Change Opt. F1: General Help F2: Previous Values F3: Optimized Defaults F4: Save & Exit ESC: Exit </pre> |
|--|--|

Version 2.17.1249. Copyright (C) 2016 American Megatrends, Inc.

- ✓ **North Bridge**
Sub menu: see "North Bridge" (page 55)
- ✓ **South Bridge**
Sub menu: see "South Bridge" (page 59)

5.4.1 North Bridge

Aptio Setup Utility - Copyright (C) 2016 American Megatrends, Inc.
Chipset

| | |
|---|--|
| <pre> ▶ Intel IGD Configuration ▶ Graphics Power Management Control Memory Information Total Memory 8192 MB (LPDDR3) Memory Slot0 8192 MB (LPDDR3) Memory Slot1 Not Present Max TOLUD [Dynamic] </pre> | <pre> Config Intel IGD Settings. ----- ←: Select Screen ↑: Select Item Enter: Select +/-: Change Opt. F1: General Help F2: Previous Values F3: Optimized Defaults F4: Save & Exit ESC: Exit </pre> |
|---|--|

Version 2.17.1249. Copyright (C) 2016 American Megatrends, Inc.

- ✓ **Intel IGD Configuration**
Sub menu: see "Intel IGD Configuration" (page 56)
- ✓ **Graphics Power Management Control**
Sub menu: see "Graphics Power Management Control" (page 58)
- ✓ **Total Memory**
Options: none
- ✓ **Memory SlotX**
Options: none
- ✓ **Max TOLUD**
Options: Dynamic / 1GB / 1.25GB / .. / 3GB

5.4.1.1 Intel IGD Configuration

Aptio Setup Utility - Copyright (C) 2016 American Megatrends, Inc.
Chipset

| | | |
|--|--|--|
| GOP Configuration Enable GOP-driver via CSM Configuration-Video Intel IGD Configuration Integrated Graphics Device [Enabled] IGD Turbo Enable [Enabled] Primary Display [IGD] PAVC [LITE Mode] DVMT Pre-Allocated [64M] DVMT Total Gfx Mem [256MB] Aperture Size [256MB] DOP CG [Enabled] GTT Size [2MB] Spread Spectrum Clock [Disabled] ISP Enable/Disable [Enabled] ISP PCI Device Selection [Disabled] Vcc, Vnn Configuration for Power state2: Vcc_Vnn Config for Power state2 [Disabled] | | Enable: Enable Integrated Graphics Device (IGD) when selected as the Primary Video Adaptor. Disable: Always disable IGD ←: Select Screen ↑↓: Select Item Enter: Select +/-: Change Opt. F1: General Help F2: Previous Values F3: Optimized Defaults F4: Save & Exit ESC: Exit |
|--|--|--|

Version 2.17.1249. Copyright (C) 2016 American Megatrends, Inc.

- ✓ **Integrated Graphics Device**
Options: Enabled / Disabled
- ✓ **IGD Turbo Enable**
Options: Enabled / Disabled
- ✓ **Primary Display**
Options: IGD / PCI
- ✓ **PAVC**
Options: Disabled / LITE Mode / SERPENT Mode
- ✓ **DVMT Pre-Allocated**
Options: 32M / 64M ... 480M / 512M
- ✓ **DVMT Total Gfx Mem**
Options: 128M / 256M / MAX
- ✓ **Aperture Size**
Options: 128MB / 256MB / 512MB
- ✓ **DOP CG**
Options: Enabled / Disabled
- ✓ **GTT Size**
Options: 1MB / 2MB
- ✓ **Spread Spectrum clock**
Options: Enabled / Disabled
- ✓ **ISP Enable/ Disable**
Options: Enabled / Disabled

✓ **ISP PCI Device Selection**

Options: Disabled / ISP PCI Device as B0D2F0 / ISP PCI Device as B0D3F0

✓ **Vcc_Vnn Config for Power state2**

Options: Enabled / Disabled

5.4.1.2 Graphics Power Management Control

Aptio Setup Utility - Copyright (C) 2016 American Megatrends, Inc.
Chipset

| | |
|--|--|
| Graphics Power Management Control RC6(Render Standby) [Enabled] | Check to enable render standby support. ←: Select Screen ↑↓: Select Item Enter: Select +/-: Change Opt. F1: General Help F2: Previous Values F3: Optimized Defaults F4: Save & Exit ESC: Exit |
|--|--|

Version 2.17.1249. Copyright (C) 2016 American Megatrends, Inc.

- ✓ **RC6 (Render Standby)**
Options: Enabled / Disabled

5.4.2 South Bridge

Aptio Setup Utility - Copyright (C) 2016 American Megatrends, Inc.
Chipset

| | |
|--|--|
| <pre> ▶ Azalia HD Audio ▶ USB Configuration ▶ PCI Express Configuration High Precision Timer [Enabled] Restore AC Power Loss [Power On] Onboard Device Configuration Onboard Gigabit LAN 1 [Enabled] Onboard Gigabit LAN 2 [Enabled] Onboard Gigabit LAN 3 [Enabled] M.2-PCIe Configuration Pins M.2-PCIe M.2-SATA Configuration Pins M.2-SATA </pre> | <p>Azalia HD Audio Options</p> <hr/> <pre> ←→: Select Screen ↑↓: Select Item Enter: Select +/-: Change Opt. F1: General Help F2: Previous Values F3: Optimized Defaults F4: Save & Exit ESC: Exit </pre> |
|--|--|

Version 2.17.1249. Copyright (C) 2016 American Megatrends, Inc.

- ✓ **Azalia HD Audio**
Sub menu: see "Azalia HD Audio" (page 60)
- ✓ **USB Configuration**
Sub menu: see "USB Configuration" (page 61)
- ✓ **PCI Express Configuration**
Sub menu: see "PCI Express Configuration" (page 62)
- ✓ **High Precision Timer**
Options: Disabled / Enabled
- ✓ **Restore AC Power Loss**
Options: Power Off / Power On / Last State
- ✓ **Onboard Gigabit LAN X**
Options: Enabled / Disabled
- ✓ **M.2-PCIe Configuration Pins**
Options: none
- ✓ **M.2-SATA Configuration Pins**
Options: none

5.4.2.1 Azalia HD Audio

Aptio Setup Utility - Copyright (C) 2016 American Megatrends, Inc.
Chipset

| | |
|--|---|
| <pre> Audio Configuration Audio Controller [Enabled] Azalia VCI Enable [Enabled] Azalia PME Enable [Enabled] Azalia HDMI Codec [Enabled] HDMI Port B [Enabled] HDMI Port C [Enabled] </pre> | <pre> Control Detection of the Azalia device. Disabled = Azalia will be unconditionally ----- ←: Select Screen ↑↓: Select Item Enter: Select +/-: Change Opt. F1: General Help F2: Previous Values F3: Optimized Defaults F4: Save & Exit ESC: Exit </pre> |
|--|---|

Version 2.17.1249. Copyright (C) 2016 American Megatrends, Inc.

- ✓ **Audio Controller**
Options: Disabled / Enabled
- ✓ **Azalia VCI Enable**
Options: Disabled / Enabled
- ✓ **Azalia PME Enable**
Options: Disabled / Enabled
- ✓ **Azalia HDMI Codec**
Options: Disabled / Enabled
- ✓ **HDMI Port X**
Options: Disabled / Enabled

5.4.2.2 USB Configuration

Aptio Setup Utility - Copyright (C) 2016 American Megatrends, Inc.
Chipset

| | |
|--|---|
| USB Configuration USB Mode [XHCI] USB Per Port Control [Enabled] USB Port 0 [Enabled] USB Port 1 [Enabled] USB Port 2 [Enabled] USB Port 3 [Enabled] | Mode of operation of xHCI controller ←: Select Screen ↑↓: Select Item Enter: Select +/-: Change Opt. F1: General Help F2: Previous Values F3: Optimized Defaults F4: Save & Exit ESC: Exit |
|--|---|

Version 2.17.1249. Copyright (C) 2016 American Megatrends, Inc.

- ✓ **USB Mode**
Options: EHCI / XHCI
- ✓ **USB Per Port Control**
Options: Enabled / Disabled
- ✓ **USB Port x**
Options: Disabled / Enabled

5.4.2.3 PCI Express Configuration

Aptio Setup Utility - Copyright (C) 2016 American Megatrends, Inc.
Chipset

| | |
|---|---|
| <p>PCI Express Configuration</p> <p>PCI Express Port 0 is assigned to LAN 1 PCI Express Port 1 is assigned to LAN 2 PCI Express Port 2 is assigned to LAN 3</p> <p>PCI Express Port 3 is assigned to M.2-PCIe</p> | <p>Enable or Disable the PCI Express Port 2 and Port 3 in the Chipset.</p> <hr/> <p>←: Select Screen ↑↓: Select Item Enter: Select +/-: Change Opt. F1: General Help F2: Previous Values F3: Optimized Defaults F4: Save & Exit ESC: Exit</p> |
|---|---|

Version 2.17.1249. Copyright (C) 2016 American Megatrends, Inc.

- ✓ **PCIe Port x is assigned to**
Options: none

5.5 Security

Aptio Setup Utility - Copyright (C) 2016 American Megatrends, Inc.

Main Advanced Chipset SECURITY Boot Save & Exit

| | |
|---|--|
| Password Description Minimum length 3 Maximum length 20 Administrator Password ▶ Secure Boot menu | Set Administrator Password ←: Select Screen ↑: Select Item Enter: Select +/-: Change Opt. F1: General Help F2: Previous Values F3: Optimized Defaults F4: Save & Exit ESC: Exit |
|---|--|

Version 2.17.1249. Copyright (C) 2016 American Megatrends, Inc.

✓ Secure Boot menu

Sub menu: see "Secure Boot menu" (page 64)

5.5.1 Secure Boot menu

Aptio Setup Utility - Copyright (C) 2016 American Megatrends, Inc.
Main Advanced Chipset SECURITY Boot Save & Exit

| | | |
|------------------|------------|---|
| Sytem Mode | Setup | Secure Boot can be enabled if 1.System running in User mode with enrolled Platform Key(PK) 2.CSM function is disabled |
| Secure Boot | Not Active | |
| Vendor Keys | Not Active | |
| Secure Boot | [Disabled] | <pre> --: Select Screen ↑↓: Select Item Enter: Select +/-: Change Opt. F1: General Help F2: Previous Values F3: Optimized Defaults F4: Save & Exit ESC: Exit </pre> |
| Secure Boot Mode | [Custom] | |
| ▶ Key Management | | |

Version 2.17.1249. Copyright (C) 2016 American Megatrends, Inc.

- ✓ **System Mode**
Options: none
- ✓ **Secure Boot**
Options: none
- ✓ **Vendor Keys**
Options: none
- ✓ **Secure Boot Mode**
Options: Standard / Custom
- ✓ **Key Management**
Sub menu: see "Key Management" (page 65)

5.5.1.1 Key Management

Aptio Setup Utility - Copyright (C) 2016 American Megatrends, Inc.
Security

| Provision Factory Default [Disabled] ▶ Enroll all Factory Default Keys ▶ Save all Secure Boot Variables <table border="1"> <thead> <tr> <th>Secure Boot variable</th> <th>Size</th> <th>Key#</th> <th>Key source</th> </tr> </thead> <tbody> <tr> <td>▶ Platform Key(PK)</td> <td>0</td> <td>0</td> <td></td> </tr> <tr> <td>▶ Key Exchange Keys</td> <td>0</td> <td>0</td> <td></td> </tr> <tr> <td>▶ Authorized Signatures</td> <td>0</td> <td>0</td> <td></td> </tr> <tr> <td>▶ Forbidden Signatures</td> <td>0</td> <td>0</td> <td></td> </tr> <tr> <td>▶ Authorized TimeStamps</td> <td>0</td> <td>0</td> <td></td> </tr> </tbody> </table> | Secure Boot variable | Size | Key# | Key source | ▶ Platform Key(PK) | 0 | 0 | | ▶ Key Exchange Keys | 0 | 0 | | ▶ Authorized Signatures | 0 | 0 | | ▶ Forbidden Signatures | 0 | 0 | | ▶ Authorized TimeStamps | 0 | 0 | | Install factory default Secure Boot keys when System is in Setup Mode. ←: Select Screen ↑↓: Select Item Enter: Select +/-: Change Opt. F1: General Help F2: Previous Values F3: Optimized Defaults F4: Save & Exit ESC: Exit |
|---|----------------------|------|------------|------------|--------------------|---|---|--|---------------------|---|---|--|-------------------------|---|---|--|------------------------|---|---|--|-------------------------|---|---|--|---|
| Secure Boot variable | Size | Key# | Key source | | | | | | | | | | | | | | | | | | | | | | |
| ▶ Platform Key(PK) | 0 | 0 | | | | | | | | | | | | | | | | | | | | | | | |
| ▶ Key Exchange Keys | 0 | 0 | | | | | | | | | | | | | | | | | | | | | | | |
| ▶ Authorized Signatures | 0 | 0 | | | | | | | | | | | | | | | | | | | | | | | |
| ▶ Forbidden Signatures | 0 | 0 | | | | | | | | | | | | | | | | | | | | | | | |
| ▶ Authorized TimeStamps | 0 | 0 | | | | | | | | | | | | | | | | | | | | | | | |

Version 2.17.1249. Copyright (C) 2016 American Megatrends, Inc.

- ✓ **Provision Factory Default keys**
Options: Enabled / Disabled
- ✓ **Enroll All Factory Default Keys**
Options: Press [Enter]
- ✓ **Save All Secure Boot Variables**
Options: Press [Enter]
- ✓ **Platform Key(PK)**
Options: Set New Key
- ✓ **Key Exchange Keys**
Options: Set New Key / Append Key
- ✓ **Authorized Signatures**
Options: Set New Key / Append Key
- ✓ **Forbidden Signatures**
Options: Set New Key / Append Key
- ✓ **Authorized TimeStamps**
Options: Set New Key / Append Key

5.6 Boot

Aptio Setup Utility - Copyright (C) 2016 American Megatrends, Inc.

Main Advanced Chipset Security BOOT Save & Exit

| | | |
|--|-------------------|--|
| Boot Configuration | | Number of 1/10 sec. to wait for setup activation key. 0 means no wait. |
| Setup Prompt Timeout | 5 | |
| Bootup NumLock State | [On] | |
| Full Screen Logo | [Enabled] | |
| Fast Boot | [Enabled] | |
| VGA Support | [EFI Driver] | |
| USB Support | [Partial Initial] | |
| PS2 Devices Support | [Enabled] | |
| NetWork Stack Driver Support | [Disabled] | |
| Boot mode select | [LEGACY] | |
| FIXED BOOT ORDER Priorities | | ←: Select Screen |
| Boot Option #1 | [Hard Disk] | ↑↓: Select Item |
| Boot Option #2 | [CD/DVD] | Enter: Select |
| Boot Option #3 | [USB Hard Disk] | +/-: Change Opt. |
| Boot Option #4 | [USB CD/DVD] | F1: General Help |
| Boot Option #5 | [USB Key] | F2: Previous Values |
| Boot Option #6 | [USB Floppy] | F3: Optimized Defaults |
| Boot Option #7 | [Network] | F4: Save & Exit |
| ▶ Advanced Fixed Boot Order Parameters | | ESC: Exit |

Version 2.17.1249. Copyright (C) 2016 American Megatrends, Inc.

- ✓ **Setup Prompt Timeout**
Options: 0...65535 [x 1/10 sec.]
- ✓ **Bootup NumLock State**
Options: On / Off
- ✓ **Full Screen Logo**
Options: Disabled / Enabled
- ✓ **Fast Boot**
Options: Disabled / Enabled
- ✓ **VGA Support**
Options: Auto / EFI Driver
- ✓ **USB Support**
Options: Disabled / Full Initial / Partial Initial
- ✓ **PS2 Devices Support**
Options: Disabled / Enabled
- ✓ **NetWork Stack Driver Support**
Options: Disabled / Enabled
- ✓ **Boot mode select**
Options: Legacy / UEFI / DUAL
- ✓ **Boot Option Priorities**
Options: Reihenfolge der Boot-Devices überprüfen/ändern
- ✓ **Advanced Fixed Boot Order Parameters**
Sub menu: see "Advanced Fixed Boot Order Parameters" (page 67)

5.6.1 Advanced Fixed Boot Order Parameters

Aptio Setup Utility - Copyright (C) 2016 American Megatrends, Inc.
Advanced

| | | |
|------------------------------|-----|--|
| Max. CFast/SSD capacity (GB) | 200 | Enable or Disable the High Precision Event Timer |
| Max. USB Stick capacity (GB) | 64 | |

| | |
|--|--|
| ←: Select Screen ↑: Select Item Enter: Select +/-: Change Opt. F1: General Help F2: Previous Values F3: Optimized Defaults F4: Save & Exit ESC: Exit | |
|--|--|

Version 2.17.1249. Copyright (C) 2016 American Megatrends, Inc.

- ✓ **Max. CFast/SSD capacity (GB)**
Options: none
- ✓ **Max USB Stick capacity (GB)**
Options: none

5.7 Save & Exit

Aptio Setup Utility - Copyright (C) 2016 American Megatrends, Inc.

Main Advanced Chipset Security Boot SAVE & EXIT

| | |
|--|---|
| <pre> Save Changes and Reset Discard Changes and Reset Restore Optimized Defaults Boot Override IBA GE Slot 0100 v1553 WinCE ▶ Reset System with ME disable ModeMEUD000 </pre> | <pre> Reset the system after saving the changes. ----- ←: Select Screen ↑: Select Item Enter: Select +/-: Change Opt. F1: General Help F2: Previous Values F3: Optimized Defaults F4: Save & Exit ESC: Exit </pre> |
|--|---|

Version 2.17.1249. Copyright (C) 2016 American Megatrends, Inc.

- ✓ **Save Changes and Reset**
Options: Press [Enter]
- ✓ **Discard Changes and Reset**
Options: Press [Enter]
- ✓ **Restore Defaults**
Options: Press [Enter]
- ✓ **Reset System with ME disable ModeMEUD000**
Options: Press [Enter]

5.8 BIOS Update

If a BIOS update needs to be done, the program "DecdFlash" as well as a bootable medium which contains the newest BIOS version is used for this. It is important, that the program is started from a DOS environment without a virtual memory manager, for example "EMM386.EXE". In case such a memory manager is loaded, the program will stop with an error message.

DecdFlash is a program which provides automatic BIOS updates on any AMI-BIOS boards. All files need to be copied from the .zip-file in another directory.

The system may not be interrupted during the flash process, otherwise the update is stopped and the BIOS is destroyed afterwards.

The program should be started as follows:

```
DecdFlsh BIOS-Filename
```

After checking the name of the BIOS file and its length the BIOS will be programmed. The flashing takes nearly 75 seconds. The firmware will get updated automatically.

NOTICE

**A faulty BIOS-Update process may cause damages on the board!
Updating the BIOS in an improper way can render the board unusable.
Therefore, you should only update the BIOS if you really need the changes/corrections which come with the new BIOS version.**

Before you proceed to update the BIOS you need to make absolutely sure that you have the right BIOS file which was issued for the exact board and exact board revision that you wish to update. If you try to update the BIOS using the wrong file the board will not start up again.

6 Mechanical Drawings

NOTICE

All dimensions are in mil (1 mil = 0,0254 mm)

6.1 PCB: Outlines

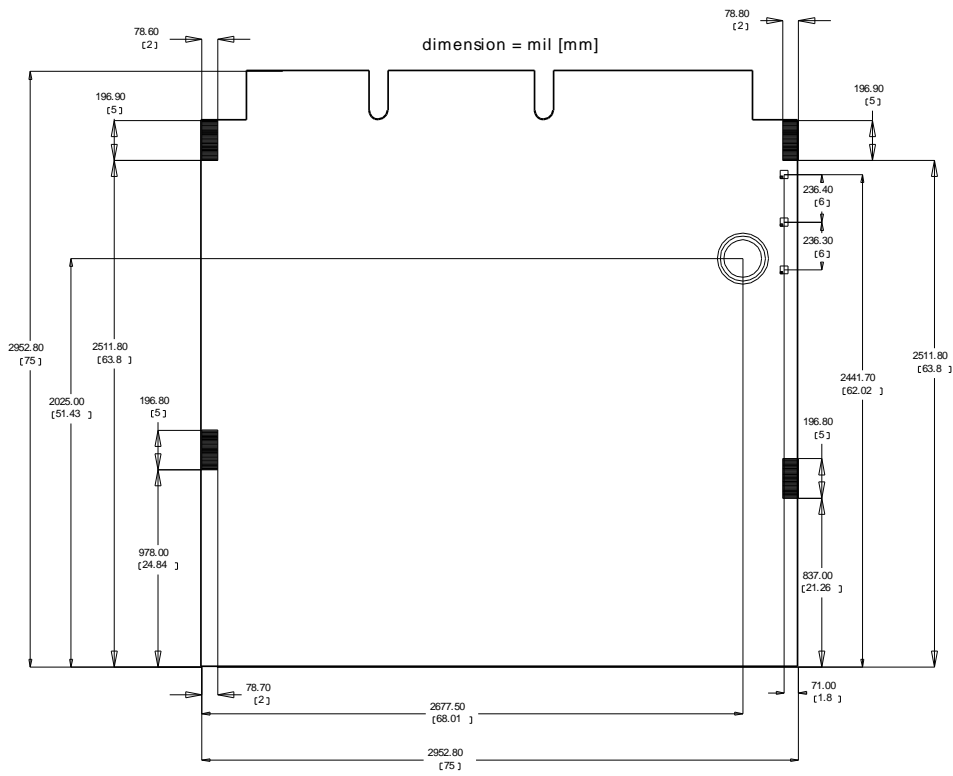

6.2 PCB: Die Center

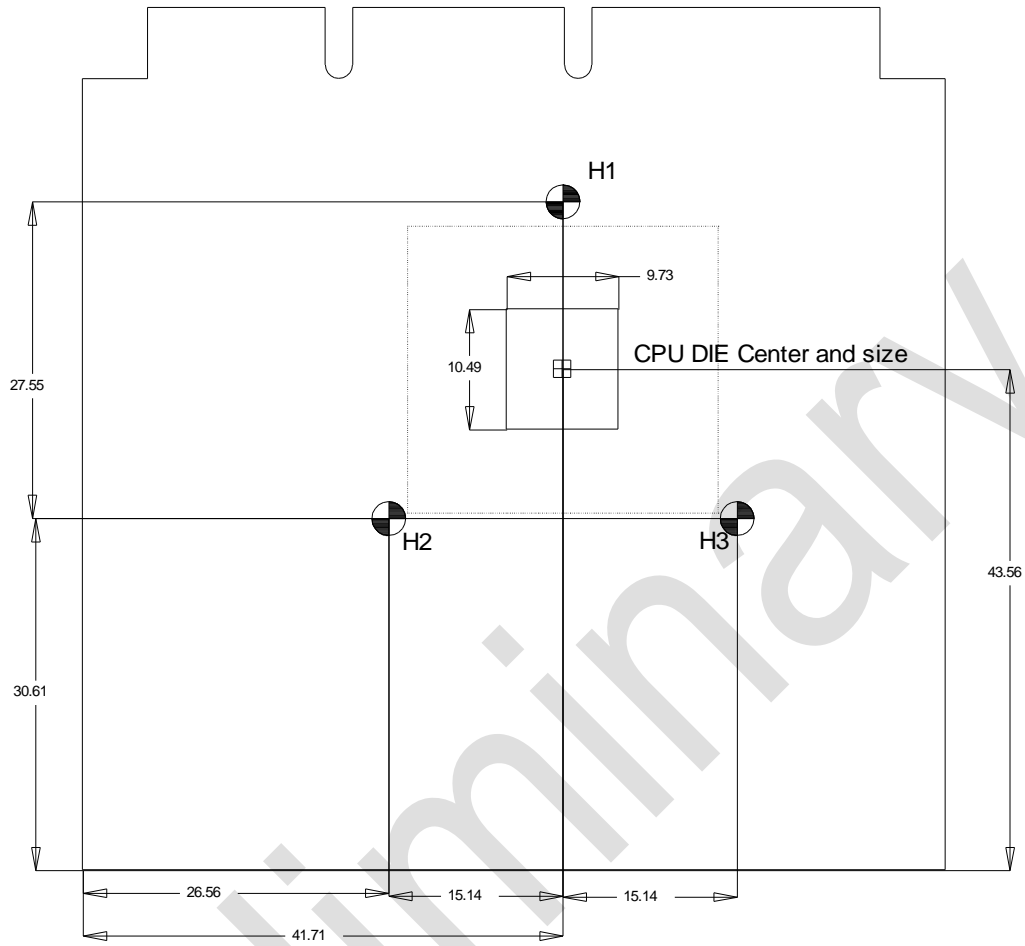

dimension=mm
H1-H3 =1,8mm x 3mm

7 Technical Data

7.1 Elektrische Daten

Power Supply:

Board: 16-30 Volt (5 Volt Fan)
 RTC: ≥ 3 Volt

Electric Power Consumption:

RTC: $\leq 10\mu\text{A}$

7.2 Environmental Conditions

Temperature Range:

Operating: -25°C to +70°C (using approved thermal solution)
 -40°C up to +85°C (when pre-screened for use with an approved thermal solution)
 Storage: -40°C up to +85°C
 Shipping: -40°C up to +85°C, for packaged boards

Temperature Changes:

Operating: 0.5°C per minute, 7.5°C per 30 minutes
 Storage: 1.0°C per minute
 Shipping: 1.0°C per minute, for packaged boards

Relative Humidity:

Operating: 5% up to 85% (non condensing)
 Storage: 5% up to 95% (non condensing)
 Shipping: 5% up to 100% (non condensing), for packaged boards

Shock:

Operating: 150m/s², 6ms
 Storage: 400m/s², 6ms
 Shipping: 400m/s², 6ms, for packaged boards

Vibration:

Operating: 10 up to 58Hz, 0.075mm amplitude
 58 up to 500Hz, 10m/s²
 Storage: 5 up to 9Hz, 3.5mm amplitude
 9 up to 500Hz, 10m/s²
 Shipping: 5 up to 9Hz, 3.5mm amplitude
 9 up to 500Hz, 10m/s², for packaged boards

NOTICE

Shock and vibration figures pertain to the motherboard alone and do not include additional components such as heat sinks, memory modules, cables etc.

7.3 Thermal Specifications

The board is specified to operate in an environmental temperature range from -25°C to +70°C when using an approved thermal solution, and an extended temperature range of -40°C to +85°C when pre-screened for use with an approved thermal solution.

Maximum die temperature is 100°C. To keep the processor under this threshold an appropriate cooling solution needs to be applied. This solution has to take typical and maximum power consumption into account. The maximum power consumption may be twice as high and should be used as a basis for the cooling concept. Additional controllers may also affect the cooling concept. The power consumption of such components may be comparable to the consumption of the processor.

The board design includes thermal solution mounting points that will provide the best possible thermal interface between die and solution. Since we take thermal solutions seriously we have several advanced, aggressive cooling solutions in our product portfolio. Please contact your sales representative to order or discuss your thermal solution needs.

NOTICE

The end customer has the responsibility to ensure that the die temperature of the processor does not exceed 100°C. Permanent overheating may destroy the board!

In case the temperature exceeds 100°C the environmental temperature must be reduced. Under certain circumstances sufficient air circulation must be provided.

Preliminary

I Annex: Post-Codes

During boot, the BIOS generates a sequence of status codes (so-called "POST codes"), which can be viewed using a special output device (POST code card). The meaning of these codes is described in the document "Aptio™ 4.x Status Codes" by American Megatrends®, which can be downloaded from their website <http://www.ami.com>. The following additional OEM POST codes are generated:

| Code | Description |
|------|--------------------------|
| 87h | BIOS-API started |
| 88h | PCA9535 started |
| 89h | PWRCTRL-Firmware started |

II Annex: Resources

Interrupt

The used resources depend on setup settings. The listed interrupts and their use are given through AT compatibility. If interrupts must exclusively be available on the ISA side, they have to be reserved through the BIOS setup. The exclusivity is not given and not possible on the PCI side.

| Adress | Function |
|----------|------------------------|
| IRQ0 | Timer |
| IRQ1 | |
| IRQ2 (8) | |
| IRQ3 | |
| IRQ4 | |
| IRQ5 | |
| IRQ6 | |
| IRQ7 | |
| IRQ8 | RTC |
| IRQ9 | |
| IRQ10 | |
| IRQ11 | SMBus Controller |
| IRQ12 | |
| IRQ13 | |
| IRQ14 | |
| IRQ15 | |
| IRQ16 | PCI Bridge(0-1) x1(x1) |
| IRQ17 | PCI Bridge(0-2) x1(x1) |
| IRQ18 | PCI Bridge(0-3) x1(x1) |
| IRQ19 | PCI Bridge(0-4) x0(x1) |
| IRQ20 | |
| IRQ21 | |
| IRQ22 | High Def Audio |

PCI Devices

All listed PCI devices exist on the board. Some PCI devices or functions of devices may be disabled in the BIOS setup. Once a device is disabled other devices may get PCI bus numbers different from the ones listed in the table.

| AD | INTA | REQ | Bus | Dev. | Fkt. | Kontroller / Slot |
|----|------|-----|-----|------|------|--------------------------------|
| - | - | - | 0 | 0 | 0 | Host Bridge ID0F00h |
| A | - | - | 0 | 2 | 0 | VGA Graphics ID0F31h |
| A | - | - | 0 | 19 | 0 | SATA (AHCI 1.0) ID0F23h |
| A | - | - | 0 | 20 | 0 | XHCI Controller ID0F35h |
| A | - | - | 0 | 27 | 0 | HD Audio ID0F04h |
| A | - | - | 0 | 28 | 0 | PCI Express Port 1 ID0F48h |
| B | - | - | 0 | 28 | 1 | PCI Express Port 2 ID0F4Ah |
| C | - | - | 0 | 28 | 2 | PCI Express Port 3 ID0F4Ch |
| D | - | - | 0 | 28 | 3 | PCI Express Port 4 ID0F4Eh |
| - | - | - | 0 | 31 | 0 | ISA Bridge ID0F1Ch |
| B | - | - | 0 | 31 | 3 | SMBus Interface ID0F12h |
| A | - | - | 1 | 0 | 0 | Ethernet Controller x1 ID1533h |
| A | - | - | 2 | 0 | 0 | Ethernet Controller x1 ID1533h |

Preliminary