

OXY5314A

3.5" SBC with Intel Tunnel Creek+Topcliff
User's Manual

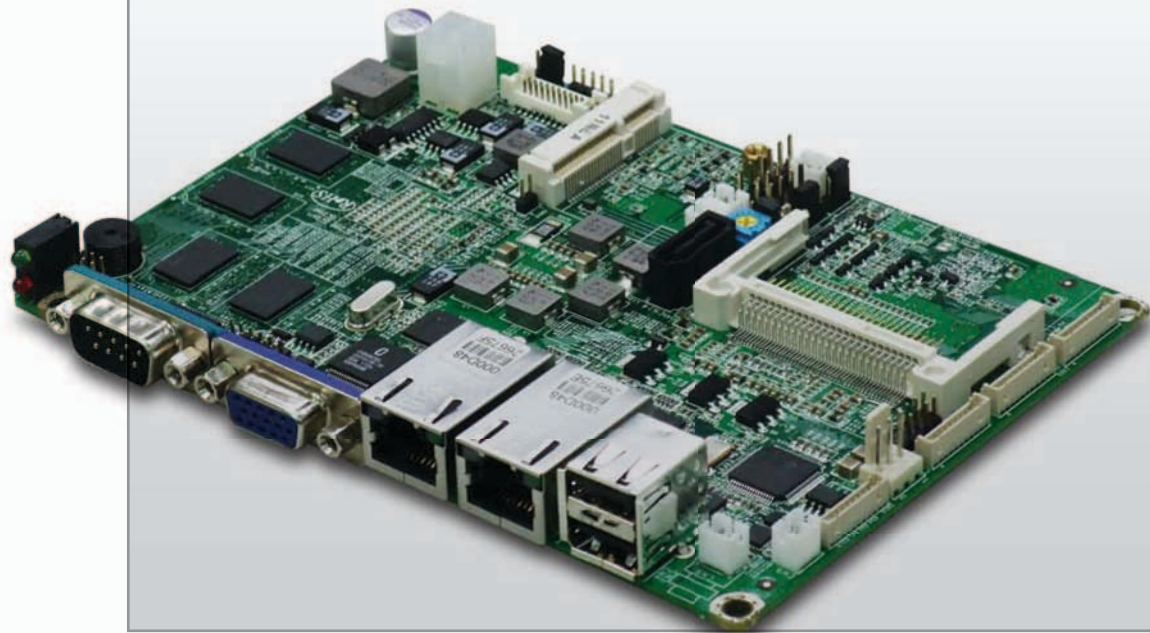

Safety Information

Electrical safety

- To prevent electrical shock hazard, disconnect the power cable from the electrical outlet before relocating the system.
- When adding or removing devices to or from the system, ensure that the power cables for the devices are unplugged before the signal cables are connected. If possible, disconnect all power cables from the existing system before you add a device.
- Before connecting or removing signal cables from the motherboard, ensure that all power cables are unplugged.
- Seek professional assistance before using an adapter or extension cord. These devices could interrupt the grounding circuit.
- Make sure that your power supply is set to the correct voltage in your area.
- If you are not sure about the voltage of the electrical outlet you are using, contact your local power company.
- If the power supply is broken, do not try to fix it by yourself. Contact a qualified service technician or your local distributor.

Operation safety

- Before installing the motherboard and adding devices on it, carefully read all the manuals that came with the package.
- Before using the product, make sure all cables are correctly connected and the power cables are not damaged. If you detect any damage, contact your dealer immediately.
- To avoid short circuits, keep paper clips, screws, and staples away from connectors, slots, sockets and circuitry.
- Avoid dust, humidity, and temperature extremes. Do not place the product in any area where it may become wet.
- Place the product on a stable surface.
- If you encounter any technical problems with the product, contact your local distributor

Statement

- All rights reserved. No part of this publication may be reproduced in any form or by any means, without prior written permission from the publisher.
- All trademarks are the properties of the respective owners.
- All product specifications are subject to change without prior notice

Revision History

Revision	Date (dd.mm.yyyy)	Changes
Version 1.0	09.August.2012	Initial release
Version 1.1	02.October.2012	Remove CN3 power button Remove CN26 DC jack Add CN23 pin define

Packing list

- 1 x OXY5314A 3.5" SBC
- 1 x CD (driver, user's manual and quick installation guide)
- 1 x Cable Kit (optional)
 - 2 x COM port cables
 - 1 x SATA cable
 - 1 x SATA power cable
 - 1 x Audio cable



If any of the above items is damaged or missing, please contact your local distributor.

Table of Contents

Safety Information	1
<i>Electrical safety.....</i>	<i>1</i>
<i>Operation safety</i>	<i>1</i>
<i>Statement</i>	<i>1</i>
<i>Revision History.....</i>	<i>2</i>
<i>Packing list.....</i>	<i>2</i>
Chapter 1: Product Information	5
1.1 <i>Block Diagram.....</i>	<i>5</i>
1.2 <i>Key Features.....</i>	<i>6</i>
1.3 <i>Board Placement.....</i>	<i>7</i>
1.4 <i>Onboard Connector List</i>	<i>8</i>
1.5 <i>Mechanical Drawings.....</i>	<i>9</i>
Chapter 2: Jumpers and Connectors.....	10
2.1 <i>Jumper Settings.....</i>	<i>10</i>
JP2: Clear CMOS.....	10
JP3: LCD BRIGHTNESS CONTROL MODE SELECT.....	10
JP4: LVDS VOLTAGE SELECT	11
JP5: AUDIO OUTPUT MODE SELECT.....	11
JP6: AT / ATX MODE SELECT	11
2.2 <i>Onboard Connector Pin Assignment</i>	<i>12</i>
CF1: CF socket	12
CN1: VGA connector	12
CN2: COM connector	12
CN4: USB connector.....	12
CN5: LPC connector.....	13
CN6/CN7: Giga LAN RJ45 connector.....	13
CN8: Power Switch pin header.....	13
CN9: Reset pin header.....	13
CN10: CANBUS connector.....	13
CN11: SATA Power connector.....	14
CN12:GPIO	14
CN13/16/22: COM port connector	14
CN14: SATA connector.....	14
CN17: 2W Audio output pin header.....	14
CN18: 2W Audio output pin header.....	15
CN19: Mini PCIe socket	15
CN15: Mini PCIe LED	15
CN20: Battery Connector	15
CN21: DC Power connector.....	16
CN23: SPI.....	16
CN24: Audio connector	16
CN25: LVDS connector.....	16
CN27: SMBUS connector.....	16
CN28: Panel inverter connector.....	17

Chapter 3: Getting Started	18
3.1 <i>Installing the CF card</i>	18
3.2 <i>Disable EG20T GbE Controller instruction</i>	18
Chapter 4: AMI BIOS UTILITY	21
4.1 <i>Starting</i>	21
4.2 <i>Navigation Keys</i>	21
4.3 <i>Main Menu</i>	22
4.4 <i>Advanced Menu</i>	23
4.4.1 <i>ACPI Settings</i>	24
4.4.2 <i>CPU Configuration</i>	24
4.4.3 <i>USB Configuration</i>	25
4.4.4 <i>AHCI SATA Configuration</i>	26
4.4.5 <i>Other Function</i>	27
4.4.6 <i>Super IO Configuration</i>	28
4.4.7 <i>H/W Monitor</i>	28
4.4.8 <i>Serial Port Console Redirection</i>	29
4.5 <i>Chipset</i>	30
4.5.1 <i>North Bridge Chipset Configuration</i>	30
4.5.1 <i>South Bridge Chipset Configuration</i>	31
4.6 <i>Boot</i>	31
4.7 <i>Security</i>	32
4.8 <i>Save and exit</i>	33

Chapter 1: Product Information

1.1 Block Diagram

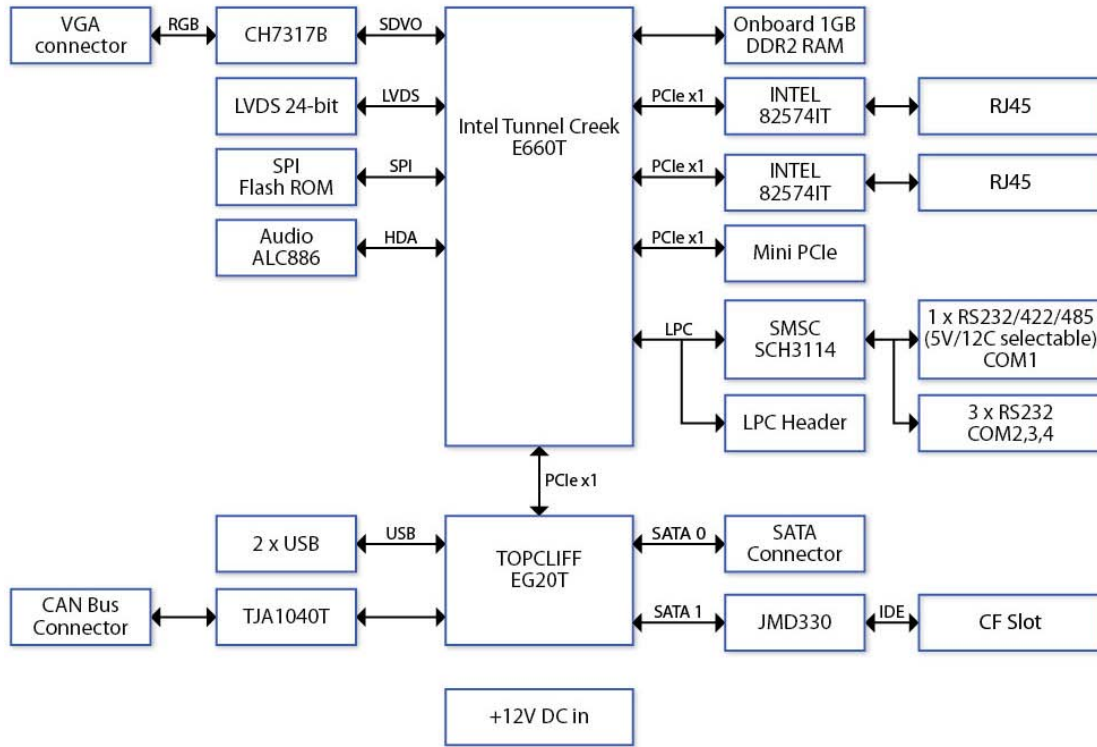

1.2 Key Features

Processor & System	
CPU Type	Intel® Atom™ Tunnel Creek E660T CPU (45nm, 1.3Ghz, 512K L2 Cache)
Chipset	Intel® Topcliff EG20T
Memory Type	Value for anti-vibration to build-in on board 1GB DDR2 memory
BIOS	AMI™ BIOS
Super I/O	SMSC SCH3114
Watchdog	1 - 255 sec. or 1 - 255 min. software programmable, can generate system reset
Expansion Slot	
Mini PCIe	1 x Mini PCIe slot (half-size)
Display	
Chipset	Chrontel 7317B SDVO to VGA transmitter
VGA	Yes (Max. resolution 1280 x 1024 @ 70Hz)
LVDS	Supports single channel 18/24-bit LVDS
Dual Displays Capability	LVDS + VGA
Audio	
Codec	Realtek ALC886 High Definition Audio Codec *2W amplifier onboard
Ethernet	
Chipset	2 x Intel® 82574IT GbE LAN
WOL	Yes
Boot from LAN	Yes for PXE
Rear I/O	
VGA	1
Ethernet	2 x RJ45
USB	2
COM	1 x RS232/422/485 with 5V/12V selection
Power Button	Optional
Internal I/O	
SATA	1 x SATAII (3Gb/s) 1 x 3 pin power connector
SSD	1 x Compact Flash Typell Socket
USB	2 ports on rear I/O
COM	4 x COM ports <ul style="list-style-type: none"> • COM1 port supports RS232/422/485 with 5V/12V selection on rear I/O • Com2~4 ports supports RS232 by 1 x 10 pin header
LVDS Connector	20 pin connector
DIO	4 in/4 out
CAN Bus	1 x 10 pin header
SMBus	1 x 2 pin header
Audio	1 x 6 pin header for Mic-in/Lin-in/Lin-out

Mechanical and Environment	
Form Factor	3.5" SBC
Power Type	12V DC-in, 4 pin ATX power connector AT/ATX mode support (optional for screw type DC jack)
Dimension	146 x 102mm (5.7" x 4")
Operating Temp.	-20°C to 70°C
Storage Temp.	-40°C to 85°C
Relative humidity	10% to 90%, non-condensing

All specifications and photos are subject to change without notice

1.3 Board Placement

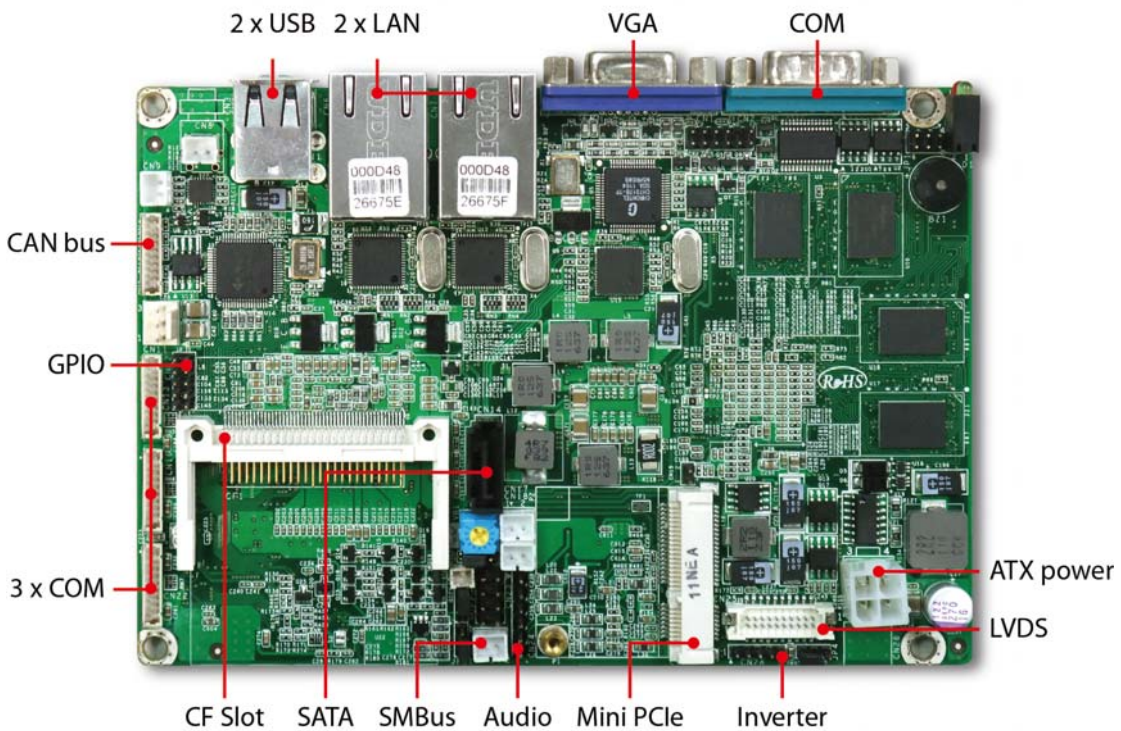

1.4 Onboard Connector List

Connector	Function
CN1	VGA
CN2	COM1
CN4	USB
CN5	Port 80
CN6	LAN
CN7	LAN
CN8	POWER SWITCH PIN HEADER
CN9	RESET
CN10	CAN BUS
CN11	HDD POWER CONNECTOR
CN12	DIO
CN13	COM4
CN14	SATA
CN15	WLAN_LED
CN16	COM3
CN17	AMP_R
CN18	AMP_L
CN19	MINI PCIE
CN20	BATTERY CONNECTOR
CN21	POWER CONNECTOR
CN22	COM2
CN23	SPI
CN24	AUDIO
CN25	LVDS
CN27	SMBUS CONNECTOR
CN28	Panel Inverter Connector
CF1	CF CONNECTOR

1.5 Mechanical Drawings

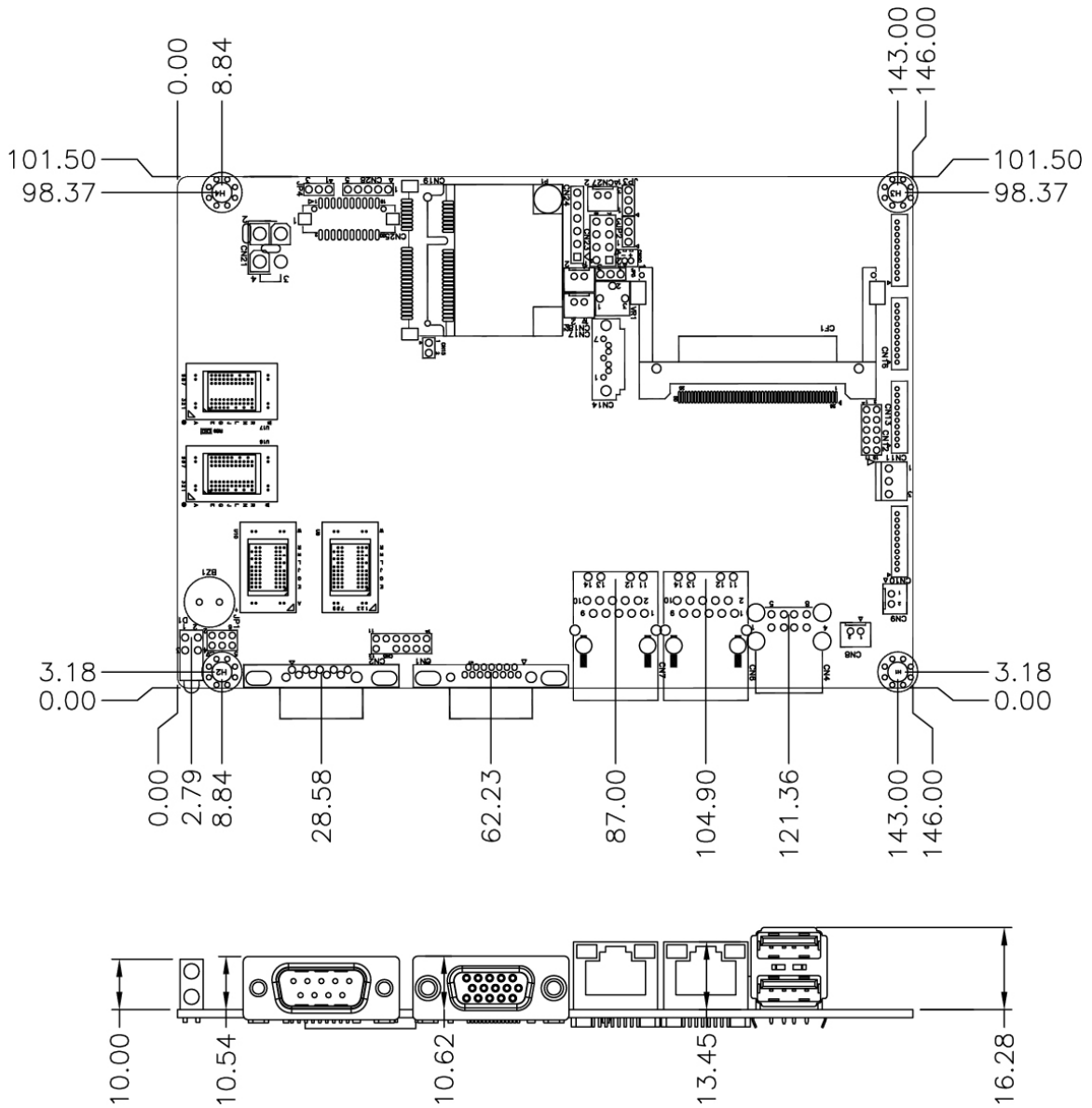

Chapter 2: Jumpers and Connectors

2.1 Jumper Settings

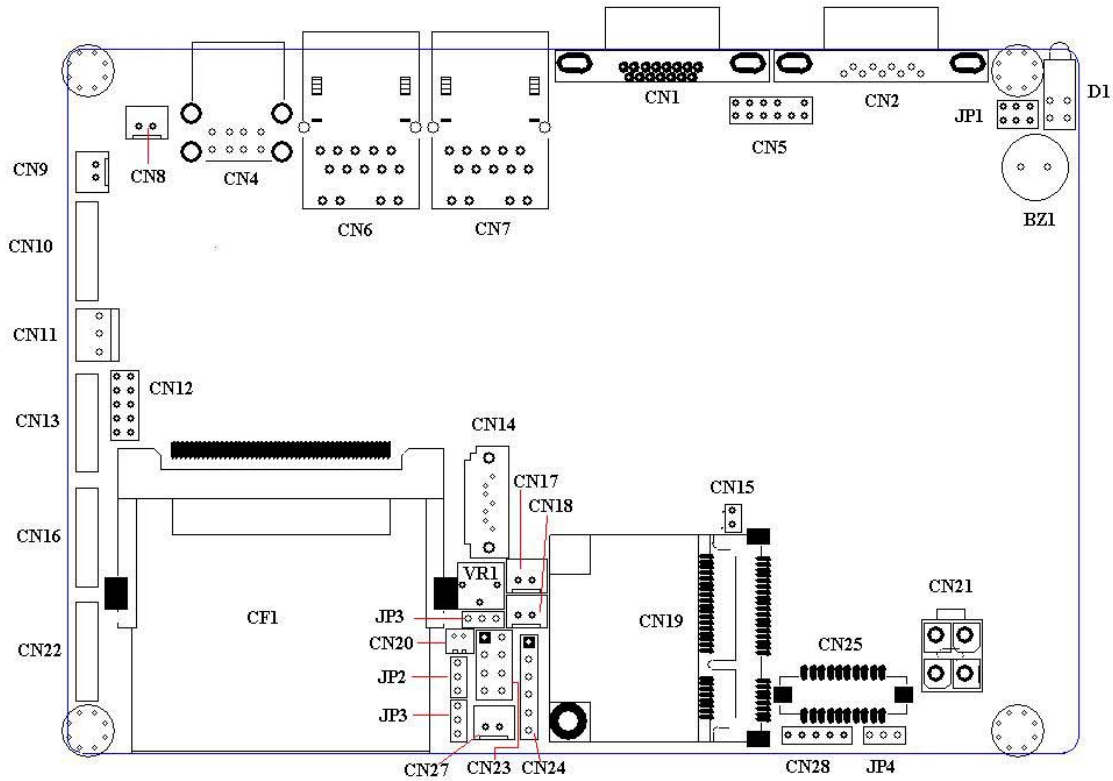

JP2: Clear CMOS

Pin	Setting	
1-2	Normal (Default)	
2-3	CLEAR CMOS	

JP3: LCD BRIGHTNESS CONTROL MODE SELECT

Pin	Setting	
1-2	DC MODE	
2-3	PWM MODE (Default)	

JP4: LVDS VOLTAGE SELECT

Pin	Setting					
1-2	+3.3V (Default)	<table border="1"> <tr> <td>1</td> <td><input checked="" type="checkbox"/></td> </tr> <tr> <td>3</td> <td><input type="checkbox"/></td> </tr> </table>	1	<input checked="" type="checkbox"/>	3	<input type="checkbox"/>
1	<input checked="" type="checkbox"/>					
3	<input type="checkbox"/>					
2-3	+5V	<table border="1"> <tr> <td>1</td> <td><input type="checkbox"/></td> </tr> <tr> <td>3</td> <td><input checked="" type="checkbox"/></td> </tr> </table>	1	<input type="checkbox"/>	3	<input checked="" type="checkbox"/>
1	<input type="checkbox"/>					
3	<input checked="" type="checkbox"/>					

JP5: AUDIO OUTPUT MODE SELECT

Pin	Setting					
1-2	SE Output Mode	<table border="1"> <tr> <td>1</td> <td><input checked="" type="checkbox"/></td> </tr> <tr> <td>3</td> <td><input type="checkbox"/></td> </tr> </table>	1	<input checked="" type="checkbox"/>	3	<input type="checkbox"/>
1	<input checked="" type="checkbox"/>					
3	<input type="checkbox"/>					
2-3	BTL Mode (Default)	<table border="1"> <tr> <td>1</td> <td><input type="checkbox"/></td> </tr> <tr> <td>3</td> <td><input checked="" type="checkbox"/></td> </tr> </table>	1	<input type="checkbox"/>	3	<input checked="" type="checkbox"/>
1	<input type="checkbox"/>					
3	<input checked="" type="checkbox"/>					

JP6: AT / ATX MODE SELECT

Pin	Setting					
1-2	ATX Mode (Default)	<table border="1"> <tr> <td>1</td> <td><input checked="" type="checkbox"/></td> </tr> <tr> <td>3</td> <td><input type="checkbox"/></td> </tr> </table>	1	<input checked="" type="checkbox"/>	3	<input type="checkbox"/>
1	<input checked="" type="checkbox"/>					
3	<input type="checkbox"/>					
2-3	AT Mode	<table border="1"> <tr> <td>1</td> <td><input type="checkbox"/></td> </tr> <tr> <td>3</td> <td><input checked="" type="checkbox"/></td> </tr> </table>	1	<input type="checkbox"/>	3	<input checked="" type="checkbox"/>
1	<input type="checkbox"/>					
3	<input checked="" type="checkbox"/>					

2.2 Onboard Connector Pin Assignment

CF1: CF socket

Pin	Define	Pin	Define	Pin	Define	Pin	Define	Pin	Define
1	GND	11	GND	21	D00	31	D15	41	RESET
2	D03	12	GND	22	D01	32	CS	42	IORDY
3	D04	13	VCC	23	D02	33	NC	43	DREG
4	D05	14	GND	24	WP	34	IOR	44	DACK
5	D06	15	GND	25	NC	35	IOW	45	LED
6	D07	16	GND	26	CD	36	WE	46	BVD
7	CS	17	GND	27	D11	37	RDY/BSY	47	D08
8	GND	18	A02	28	D12	38	VCC	48	D09
9	GND	19	A01	29	D13	39	SCSE	49	D10
10	GND	20	A00	30	D14	40	NC	50	GND

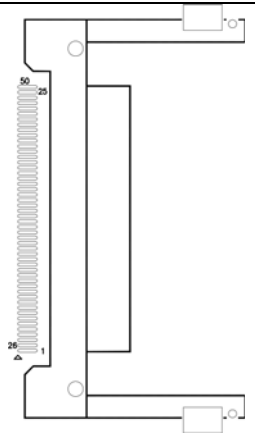

CN1: VGA connector

Pin	Define	Pin	Define
1	Red	2	Green
3	Blue	4	N.C.
5	GND	6	GND
7	GND	8	GND
9	PWR	10	GND
11	N.C.	12	DDC SDA
13	HSYNC	14	VSYNC
15	DDC SCL		

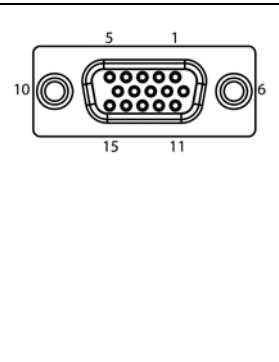

CN2: COM connector

Pin	Define	Pin	Define
1	DCD#	2	RXD#
3	TXD#	4	DTR#
5	GND	6	DSR#
7	RTS#	8	CTS#
9	RI#		

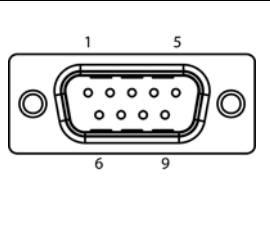

CN4: USB connector

Pin	Define	Pin	Define
1	+5V	2	DATA0-
3	DATA0+	4	GND
5	+5V	6	DATA1-
7	DATA1+	8	GND

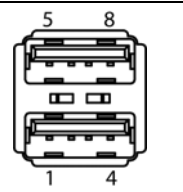

CN5: LPC connector

Pin	Define	Pin	Define
1	+3.3V	2	AD 0
3	AD 1	4	AD 2
5	AD 3	6	Frame#
7	PCIERST#	8	+5V
9	CLOCK	10	
11	GND	12	GND

CN6/CN7: Giga LAN RJ45 connector

Pin	Define
1	MDI0+
2	MDI0-
3	MDI1+
4	MDI2+
5	MDI2-
6	MDI1-
7	MDI3+
8	MDI3-

LED	
D2: Link/Activity LED	
Link	Green
Activity	Blinking
D1: Bi-Color Speed LED	
10 Mbps	Off
100 Mbps	Yellow
1000Mbps	Green

CN8: Power Switch pin header

Pin	Define
1	PW_SW
2	GND

CN9: Reset pin header

Pin	Define
1	RESET
2	GND

CN10: CANBUS connector

Pin	Define
1	GND
2	CAN_L
3	CAN_H
4	CAN_GND
5	NC
6	NC
7	+5V
8	NC
9	NC
10	NC

CN11: SATA Power connector

Pin	Define
1	GND
2	+12V
3	+5V

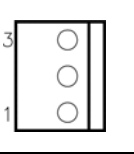

CN12:GPIO

Pin	Define	Pin	Define
1	GPI	2	GPO
3	GPI	4	GPO
5	GPI	6	GPO
7	GPI	8	GPO
9	+5V	10	GND

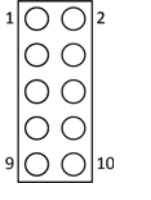

CN13/16/22: COM port connector

Pin	Define
1	DCD#
2	DSR#
3	RXD#
4	RTS#
5	TXD
6	CTS##
7	DTR#
8	RI#
9	GND
10	+5V

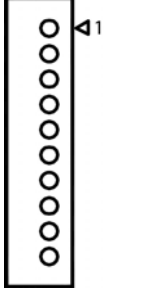

CN14: SATA connector

Pin	Define
1	GND
2	TXP
3	TXN
4	GND
5	RXN
6	RXP
7	GND

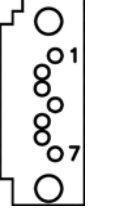

CN17: 2W Audio output pin header

Pin	Define
1	RIGHT+
2	RIGHT-



CN18: 2W Audio output pin header

Pin	Define
1	LEFT+
2	LEFT-



CN19: Mini PCIe socket

Pin	Define	Pin	Define
1	WAKE#	2	+3.3V
3	Reserved	4	GND
5	Reserved	6	+1.5V
7	CLKREQ#	8	Reserved
9	GND	10	Reserved
11	REF CLK-	12	Reserved
13	REF CLK+	14	Reserved
15	GND	16	Reserved
17	Reserved	18	GND
19	Reserved	20	Reserved
21	GND	22	PERST#
23	PERNO	24	+3.3VAUX
25	PERPO	26	GND
27	GND	28	+1.5V
29	GND	30	SMB_CLK
31	PETNO	32	SMB_DATA
33	PETPO	34	GND
35	GND	36	USB_D-
37	Reserved	38	USB_D+
39	Reserved	40	GND
41	Reserved	42	LED_WWAN#
43	Reserved	44	LED_WLAN#
45	Reserved	46	LED_WPAN#
47	Reserved	48	+1.5V
49	Reserved	50	GND
51	Reserved	52	+3.3V

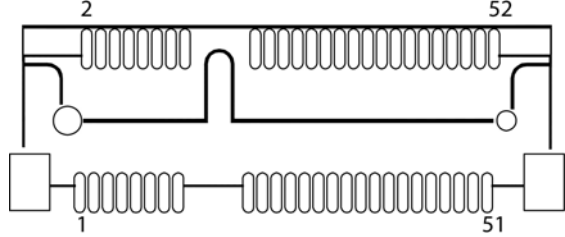

CN15: Mini PCIe LED

Pin	Define
1	+3.3V
2	LED_WLAN#



CN20: Battery Connector

Pin	Define
1	+3.3V
2	GND



CN21: DC Power connector

Pin	Define
1	GND
2	GND
3	+12V
4	+12V

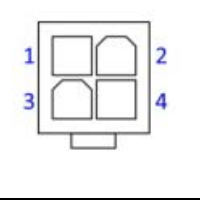

CN23: SPI

Pin	Define	Pin	Define
1	VCC3_SPI	2	GND
3	SPI_CS_N	4	SPI_CLK
5	SPI_MISO	6	SPI_MOSI
7		8	FLASH_IO

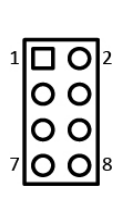

CN24: Audio connector

Pin	Define
1	SPKR_R
2	GND
3	SPKR_L
4	LINE_IN_R
5	MIC_IN
6	LINE_IN_L

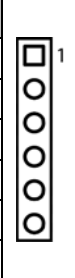

CN25: LVDS connector

Pin	Define	Pin	Define
1	TX0+	2	TX0-
3	GND	4	GND
5	TX1+	6	TX1-
7	GND	8	VCC_LCD
9	TX2+	10	TX2-
11	TXC+	12	TXC-
13	GND	14	GND
15	TX3+	16	TX3-
17	ENABKL	18	VCC_LCD
19	I2C_DAT	20	I2C_CLK

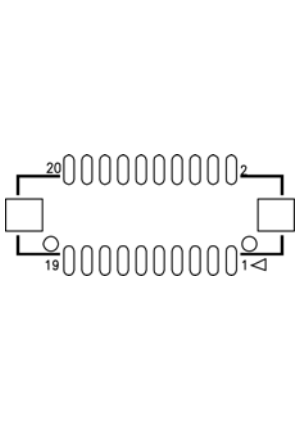

CN27: SMBUS connector

Pin	Define
1	SMB_DATA
2	SMB_CLK

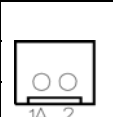

CN28: Panel inverter connector

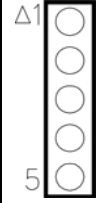
Pin	Define	
1	+12V	
2	GND	
3	Backlight Enable	
4	Brightness Control	
5	+5V	

Chapter 3: Getting Started

3.1 Installing the CF card

The OXY5314A built-in CF Type II Socket

	<p>Disconnect all power supplies to the board before installing a memory module to prevent damage to the board and memory module.</p>
---	---

To install a CF card:

Step 1: Locate the CF card socket. Locate the CompactFlash® slot.

Step 2: Align the CF card. Align the CompactFlash® card. The label side should be facing away from the board. The grooves on the CompactFlash® slot ensure that the card cannot be inserted the wrong way.

Step 3: Insert the CF card. Push until the CompactFlash® card is firmly seated in the slot

3.2 Disable EG20T GbE Controller instruction

This section will explain how to disable EG20T GbE Controller

Note: it depends on user's application.

1. Open Computer Management

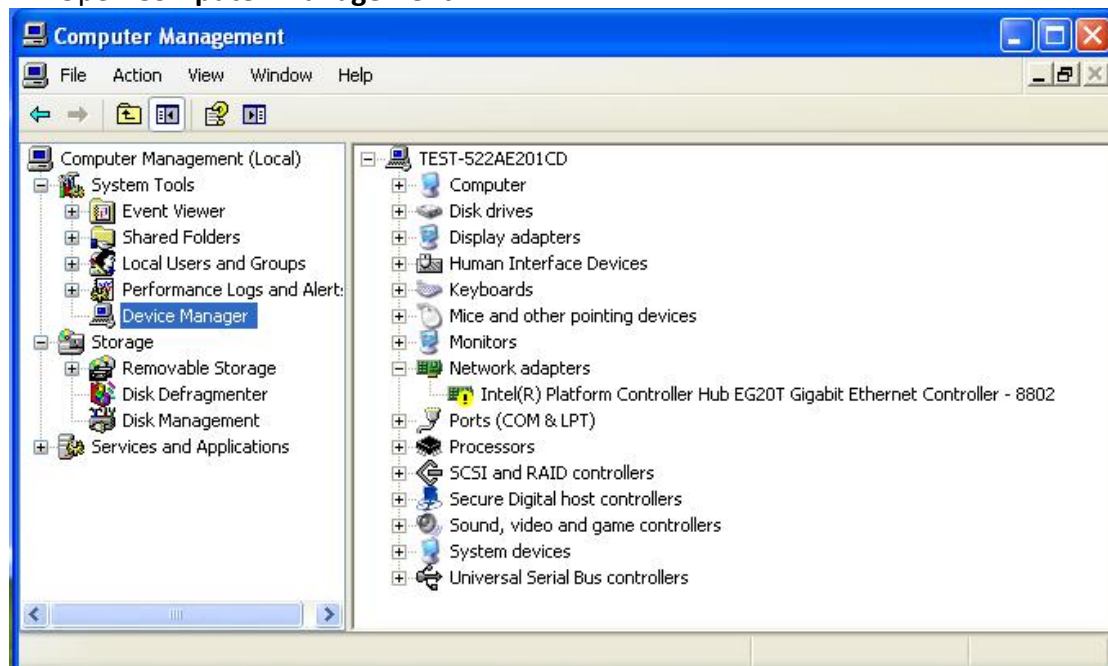

2. Choose **Device Manager**, then right click on Intel(R) Platform Controller Hub EG20T Gigabit Ethernet Controller – 8802 and select **Disable**

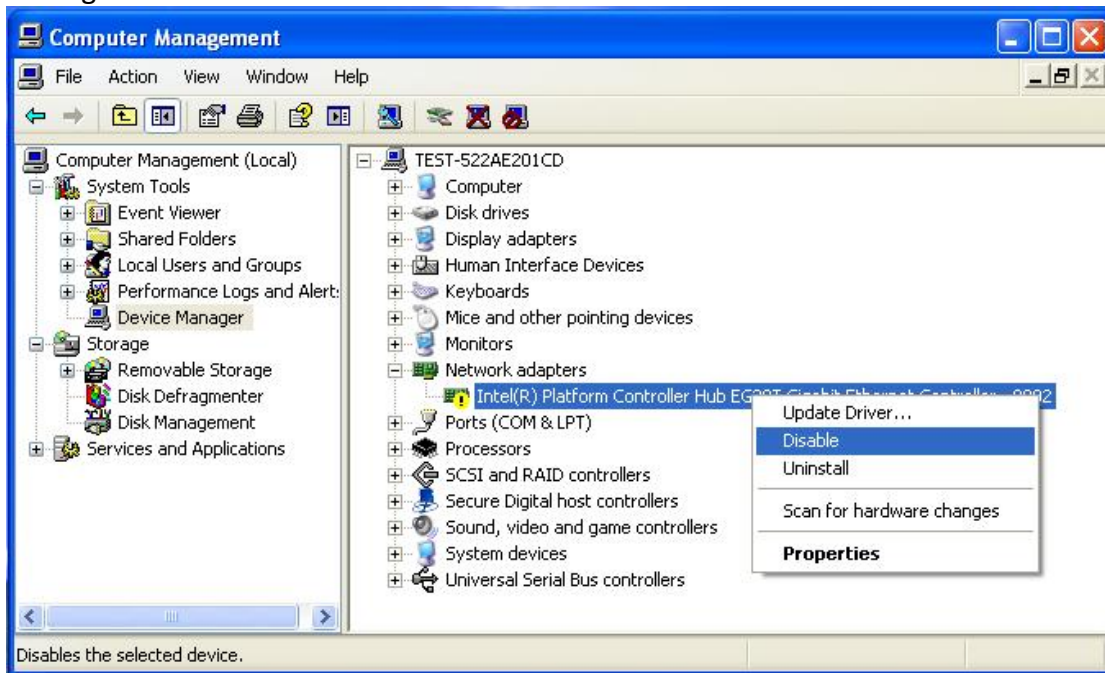

3. A window message appear, select **Yes**

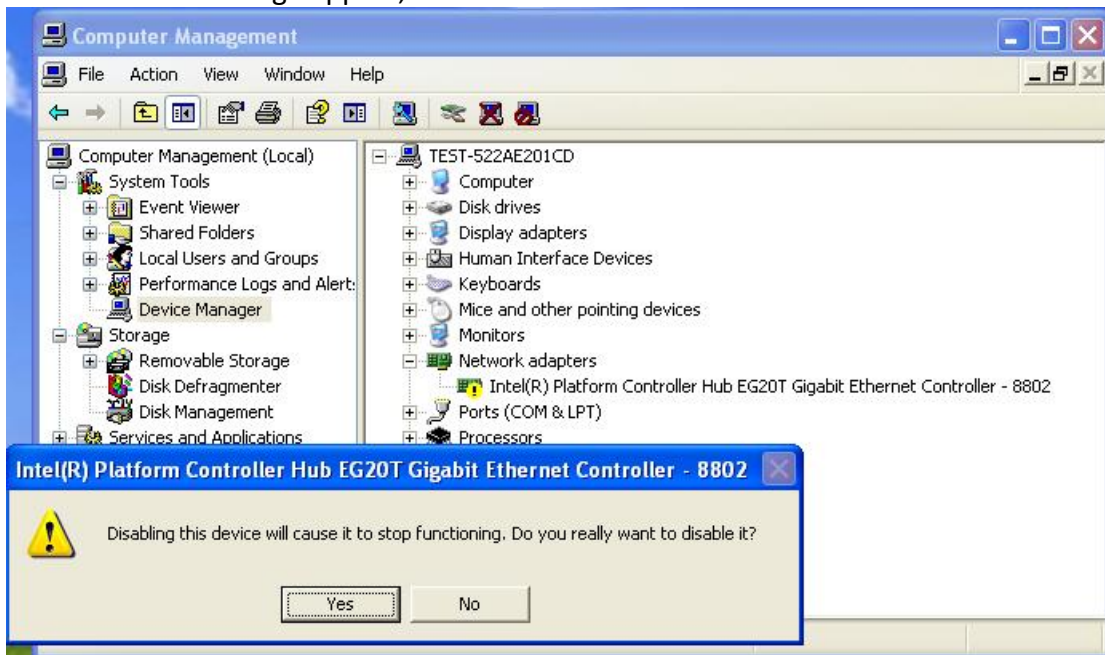

4. The device will be disabled

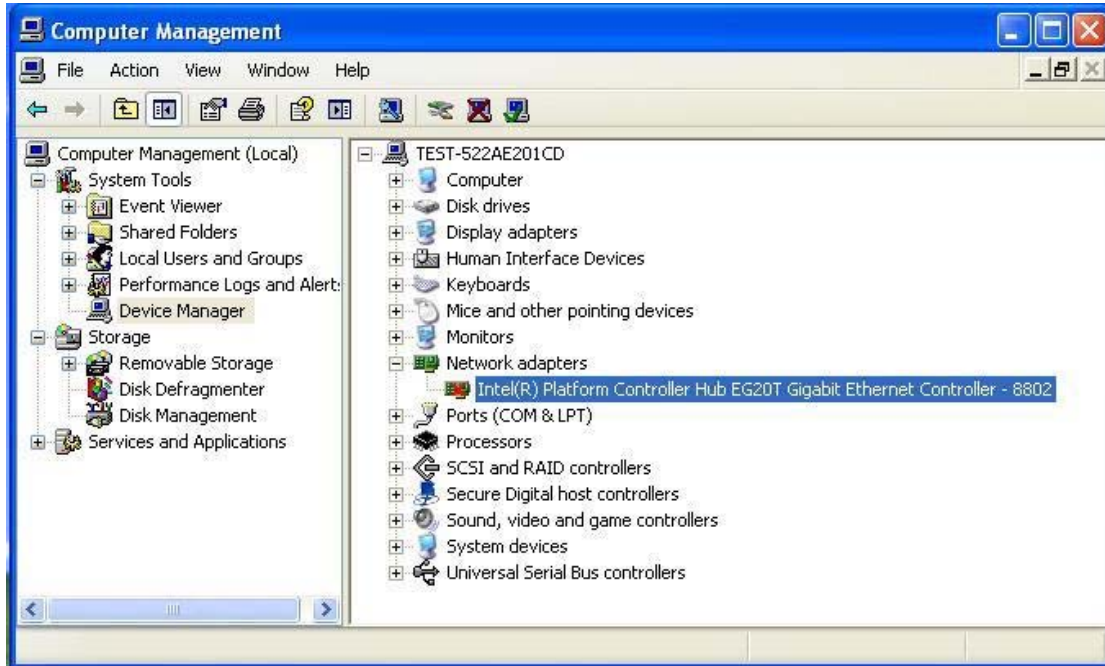

Chapter 4: AMI BIOS UTILITY

This chapter provides users with detailed descriptions on how to set up a basic system configuration through the AMI BIOS setup utility.

4.1 Starting

To enter the setup screens, perform the following steps:

- Turn on the computer and press the key immediately.
- After the key is pressed, the main BIOS setup menu displays. Other setup screens can be accessed from the main BIOS setup menu, such as the Chipset and Power menus.

4.2 Navigation Keys

The BIOS setup/utility uses a key-based navigation system called hot keys. Most of the BIOS setup utility hot keys can be used at any time during the setup navigation process. Some of the hot keys are <F1>, <F10>, <Enter>, <ESC>, and <Arrow> keys.



Some of the navigation keys may differ from one screen to another.

Left/Right	The Left and Right <Arrow> keys moves the cursor to select a menu.
Up/Down	The Up and Down <Arrow> keys moves the cursor to select a setup screen or sub-screen.
+– Plus/Minus	The Plus and Minus <Arrow> keys changes the field value of a particular setup setting.
Tab	The <Tab> key selects the setup fields.
F1	The <F1> key displays the General Help screen.
F10	The <F10> key saves any changes made and exits the BIOS setup utility.
Esc	The <Esc> key discards any changes made and exits the BIOS setup utility.
Enter	The <Enter> key displays a sub-screen or changes a selected or highlighted option in each menu.

4.3 Main Menu

The Main menu is the first screen that you will see when you enter the BIOS Setup Utility.

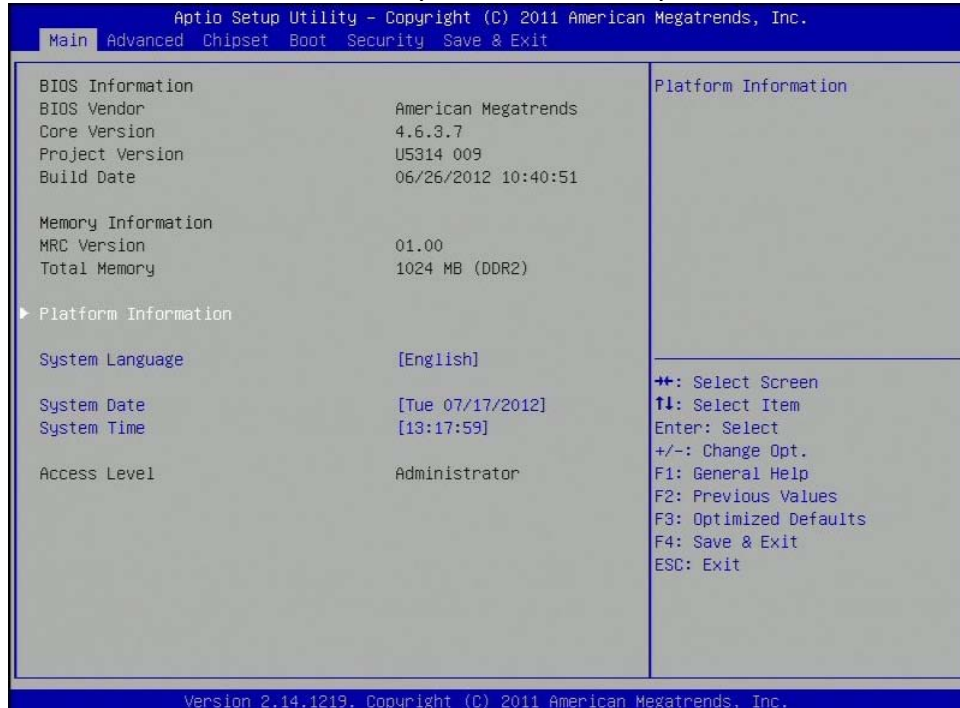

System Language

Use this function to select the system language. Currently, only English is supported.

System Date

The date format is <day>, <month>, <date>, <year>. Day displays a day, from Monday to Sunday. Month displays the month, from January to December. Date displays the date, from 1 to 31. Year displays the year, from 1999 to 2099.

System Time

The time format is <hour>, <minute>, <second>. The time is based on the 24-hour military-time clock. For example, 1 p.m. is 13:00:00. Hour displays hours from 00 to 23. Minute displays minutes from 00 to 59. Second displays seconds from 00 to 59.

Access Level

Displays the access level of the current user in the BIOS.

4.4 Advanced Menu

The Advanced menu allows you to configure your system for basic operation. Some entries are defaults required by the system board, while others, if enabled, will improve the performance of your system or let you set some features according to your preference.

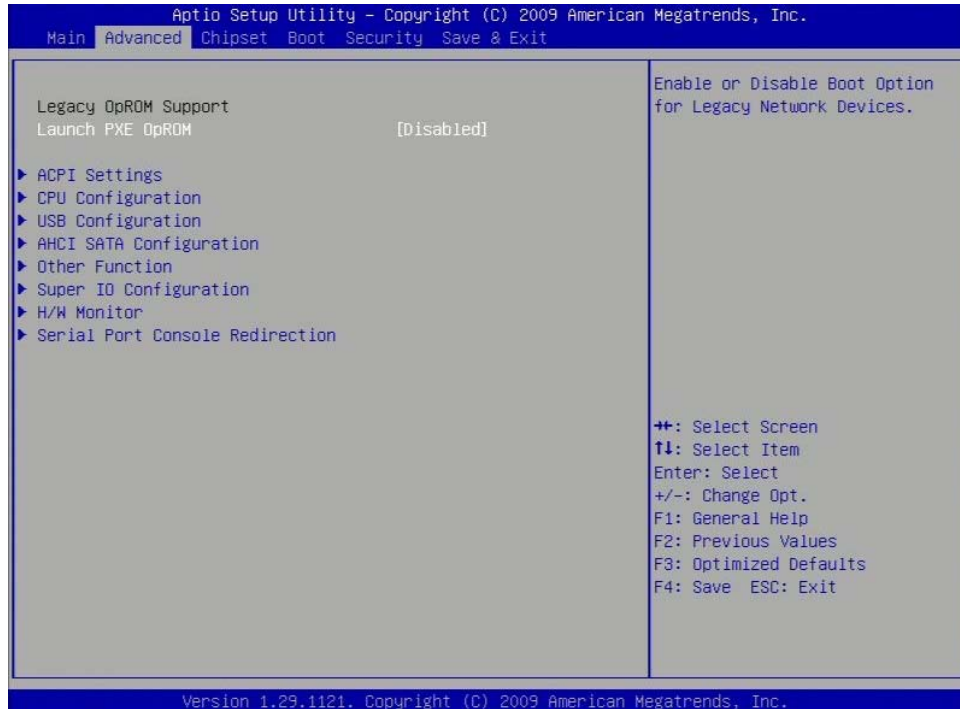

Launch PXE OpROM

Enables or disables the boot option for legacy network devices. Default setting: Disabled

4.4.1 ACPI Settings

System ACPI Parameters.

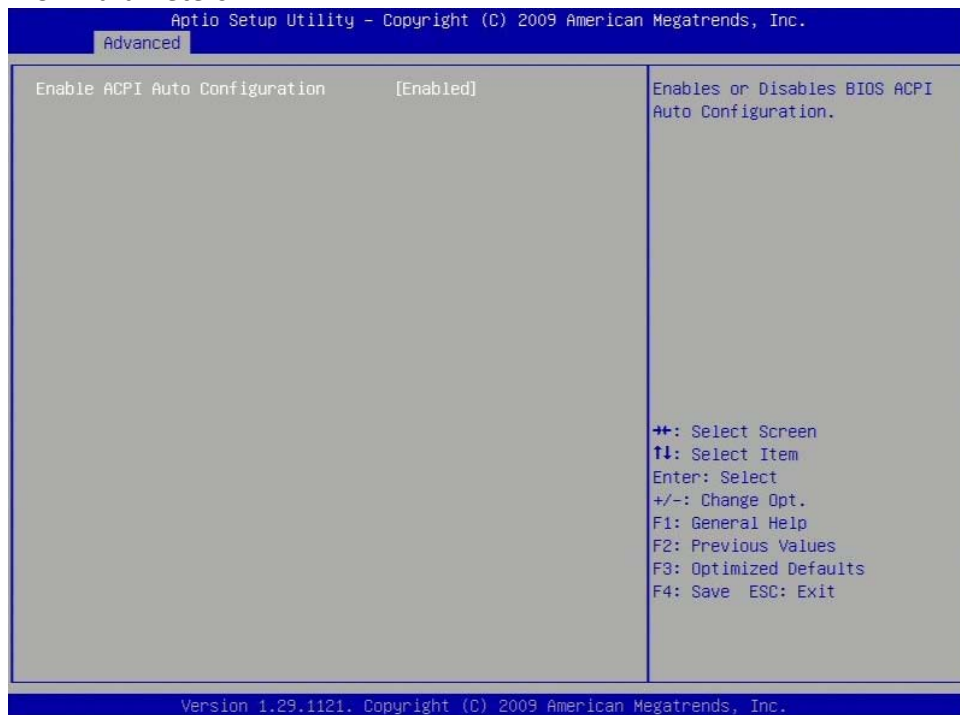

Enable ACPI Auto Configuration

Use this item to enable or disable BIOS ACPI Auto Configuration. Default setting is Enabled.

4.4.2 CPU Configuration

This section shows the CPU configuration parameters.

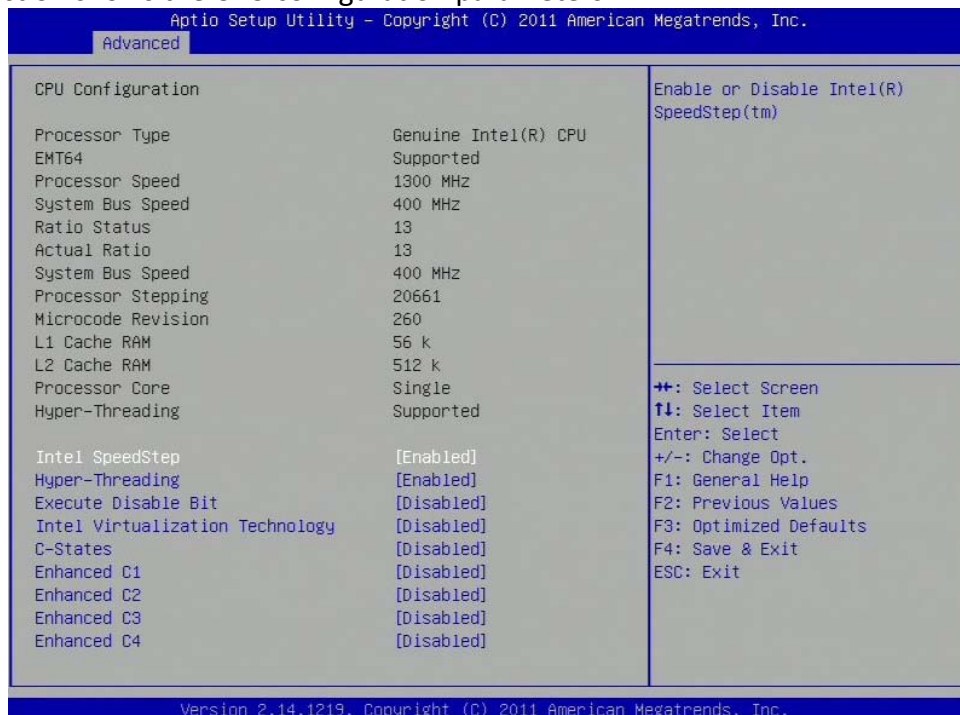

Intel SpeedStep

Enabled or Disable Intel® SpeedStep™. Default setting is Enabled.

Hyper-threading

Enabled or Disable hyper-threading technology. Default setting is Enabled.

Execute Disable Bit

When this field is set to Disabled, it will force the XD feature flag to always return to 0. XD can prevent certain classes of malicious buffer overflow attacks when combined with a supporting OS.

Intel Virtualization Technology

This function is used to enable a Virtual Machine Manager (VMM) to utilize the additional hardware capabilities provided by the Vanderpool Technology. To change the state of this function, a hardware reset is necessary. Default setting is Disabled.

C-States

Modern CPUs can be put into a deeper sleeping state when idle at the cost of longer wake-up times. Default setting is Disabled.

4.4.3 USB Configuration

This option allows the user to view and configure the settings of the USB configuration parameters.

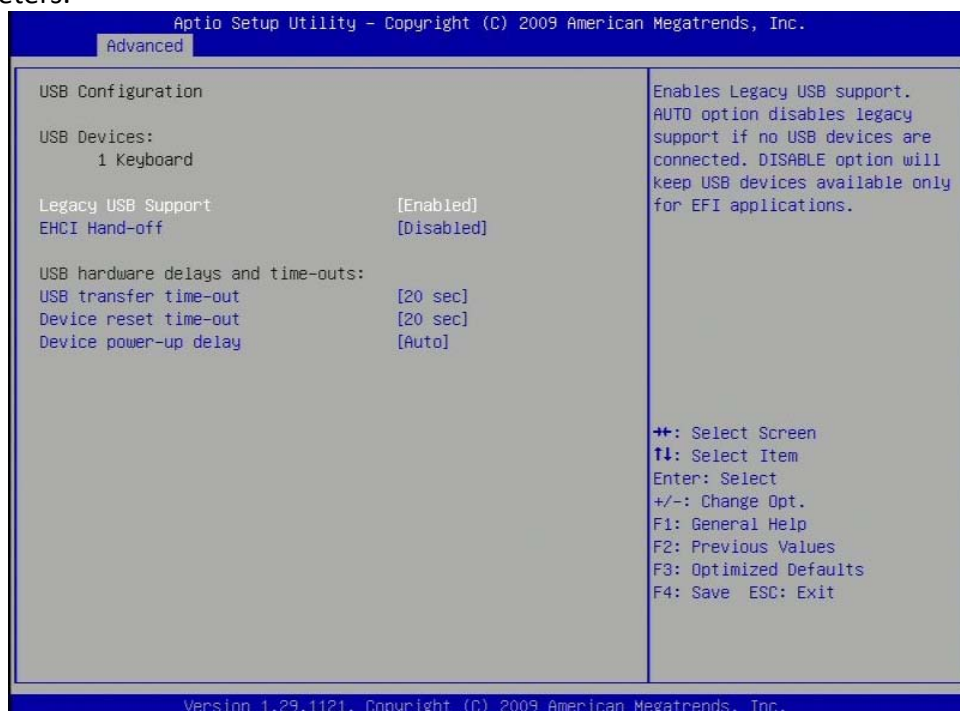

Legacy USB Support

This function is required for booting from USB devices and for operating systems which do not support USB themselves (mainly DOS and some BootLoaders). Default setting is Enabled

- Disabled Use this setting to disable legacy USB support.
- Enabled Use this setting to enable legacy USB support.
- Auto Use this setting to enable legacy USB support if there are USB devices present.

EHCI Hand-off

This is a workaround feature for Operating Systems without EHCI hand-off support. The EHCI ownership must be claimed by EHCI Driver. Default setting is Disabled.

4.4.4 AHCI SATA Configuration

This option configures the Serial ATA drives to use AHCI (Advanced Host Controller Interface). AHCI allows the storage driver to enable the advanced Serial ATA features which will increase storage performance.

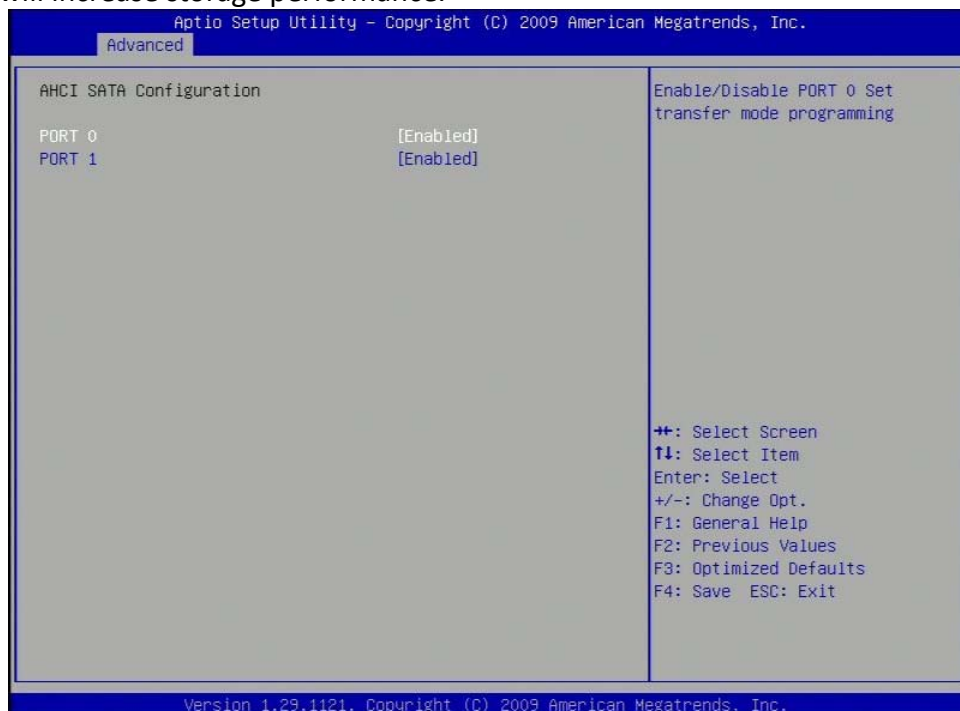

4.4.5 Other Function

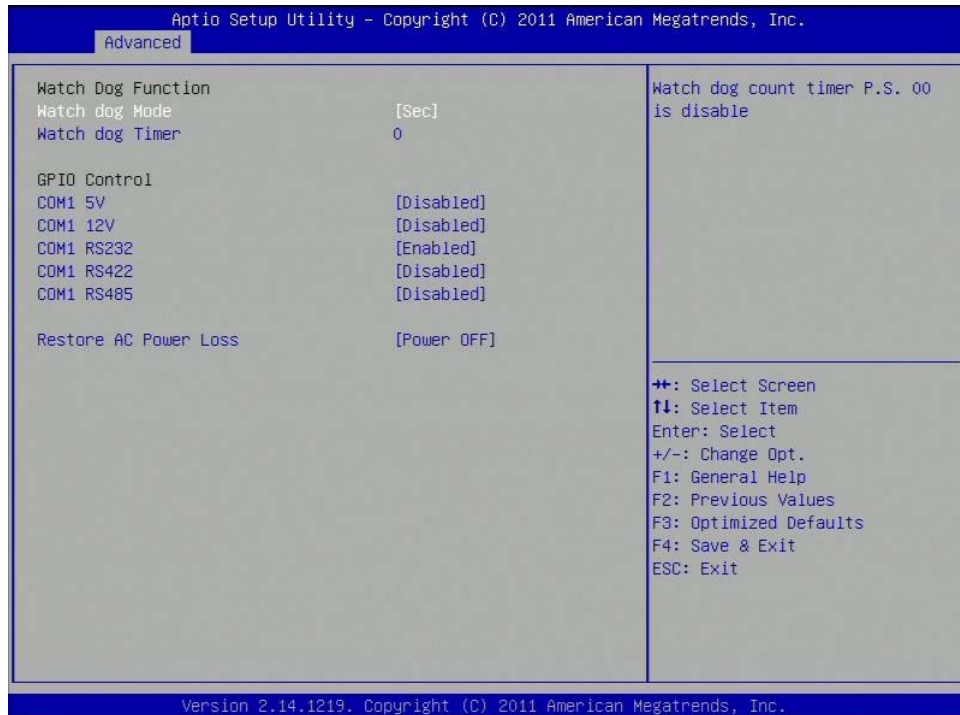

Restore AC Power Loss

- Power Off When power returns after an AC power failure, the system's power is off. You must press the power button to power-on the system.
- Power On When power returns after an AC power failure, the system will automatically power-on.
- Last State When power returns after an AC power failure, the system will return to the state where you left off before power failure occurs. If the system's power is off when AC power failure occurs, it will remain off when power returns. If the system's power is on when AC power failure occurs, the system will power-on when power returns.

4.4.6 Super IO Configuration

This section is used to configure the serial ports.

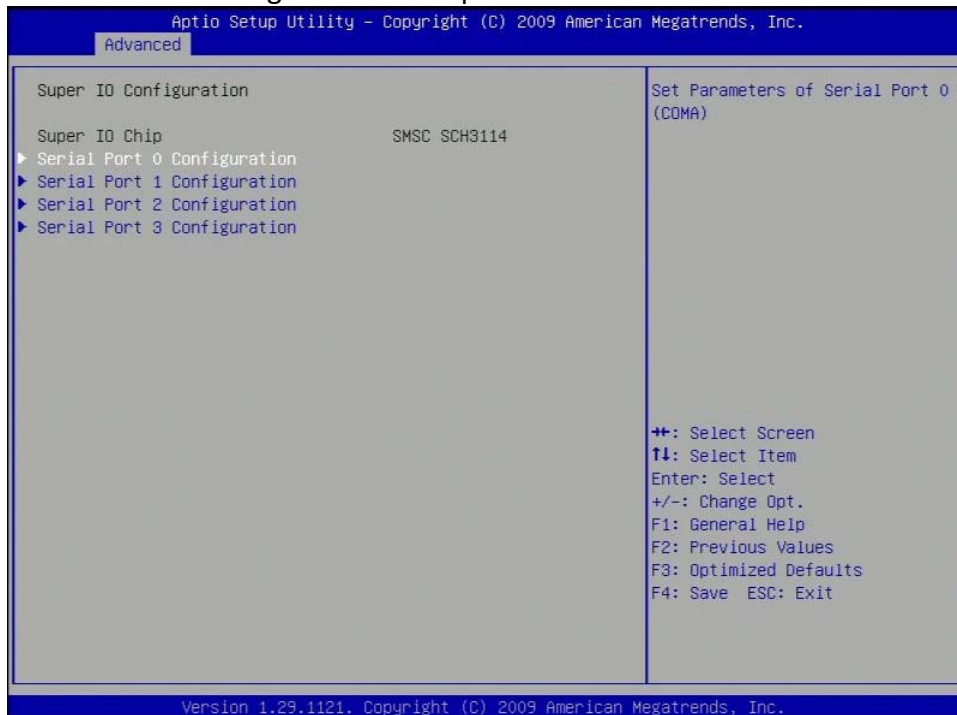

4.4.7 H/W Monitor

This section is used to monitor hardware status such as temperature, fan speed and voltages.



4.4.8 Serial Port Console Redirection

This screen provides information about functions for specifying the Serial Port Console Redirection configuration settings.

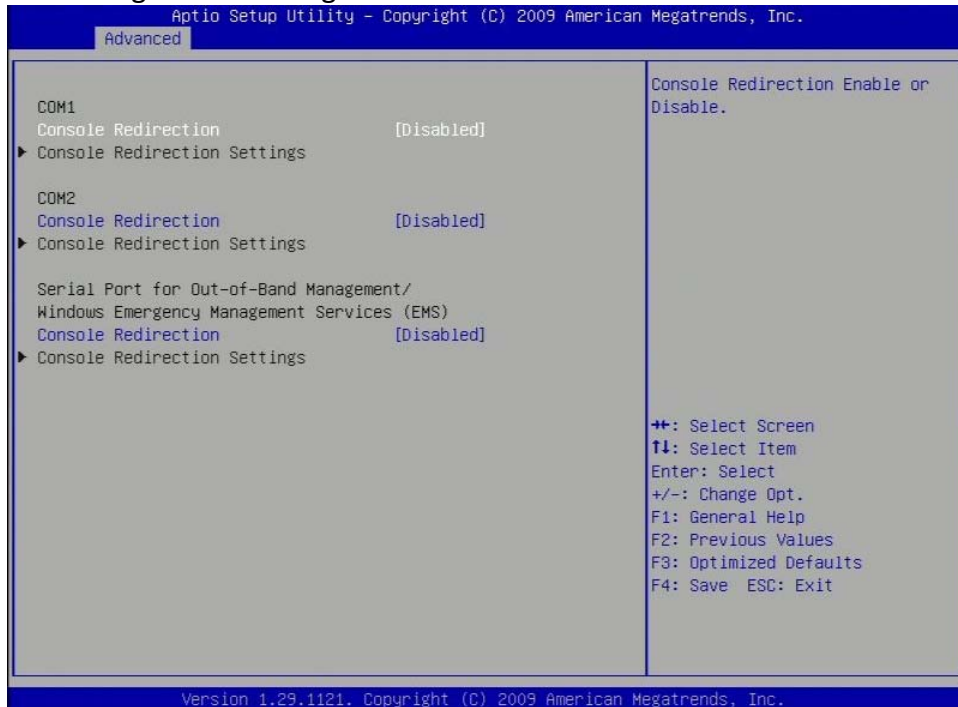

Serial Port for Out-of-Band Management/Windows Emergency Management Services (EMS)

The following functions control the presence and content of the ACPI serial port redirection table (SPCR). This table is mainly used by the Windows server variants to provide Windows Emergency Management Services (EMS). This functionality is totally independent from serial redirection of other console output.

4.5 Chipset

Select the Chipset tab to enter the Chipset Setup screen. This screen lists the chipset configuration sub screens.

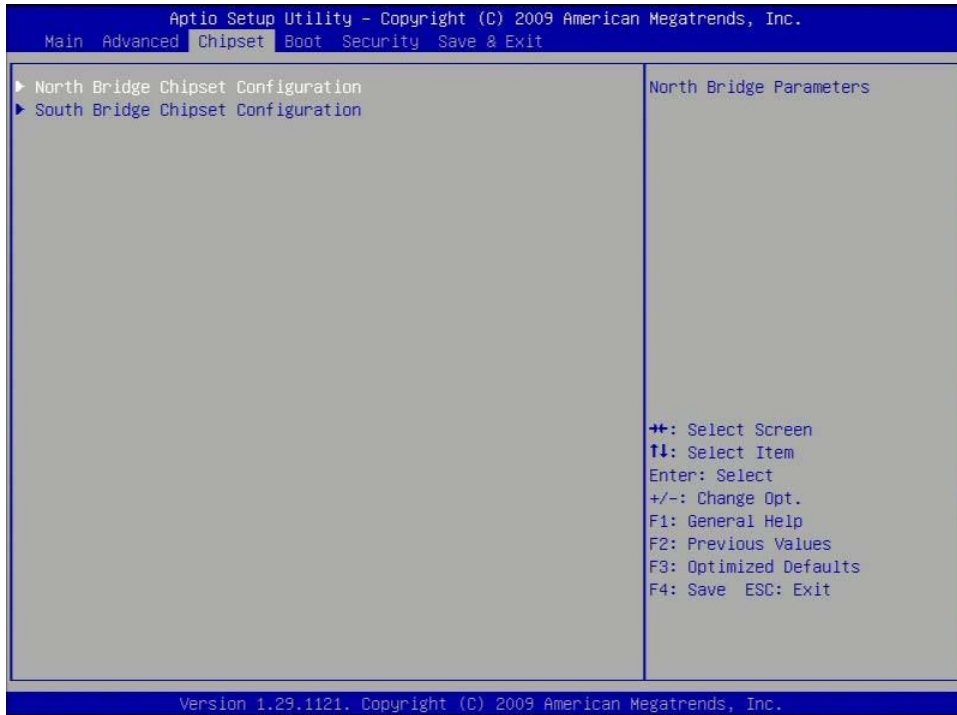

4.5.1 North Bridge Chipset Configuration

This screen provides functions for specifying the North Bridge configuration settings.



4.5.1 South Bridge Chipset Configuration

This screen provides functions for specifying the South Bridge configuration settings.

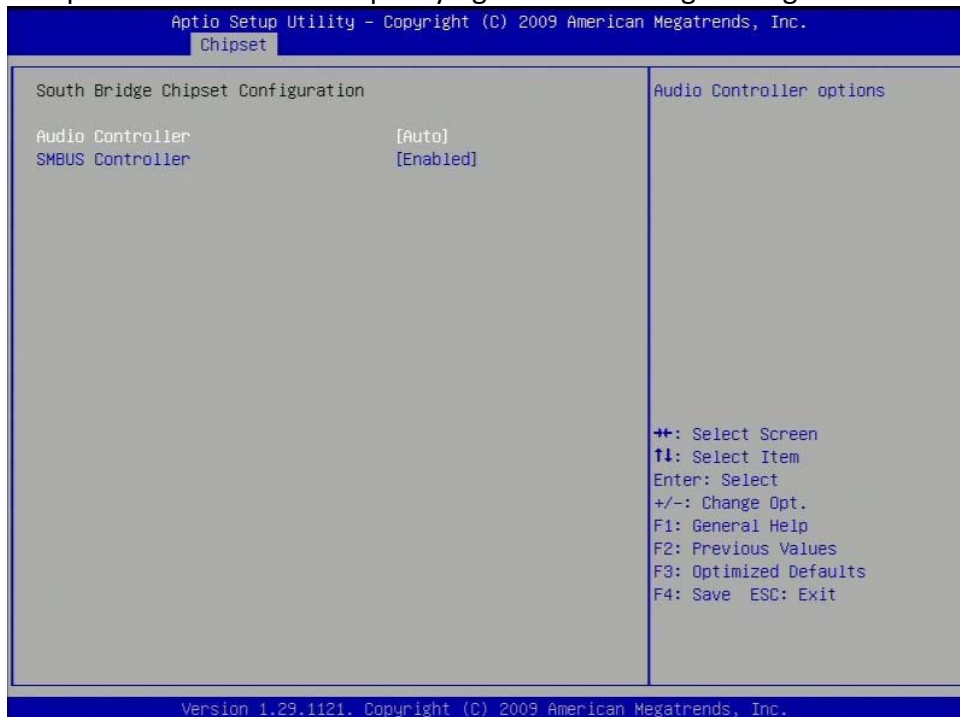

4.6 Boot

Select the Boot tab to enter the Boot Setup screen. This screen lists the sub-screens for boot configuration and boot device priority.

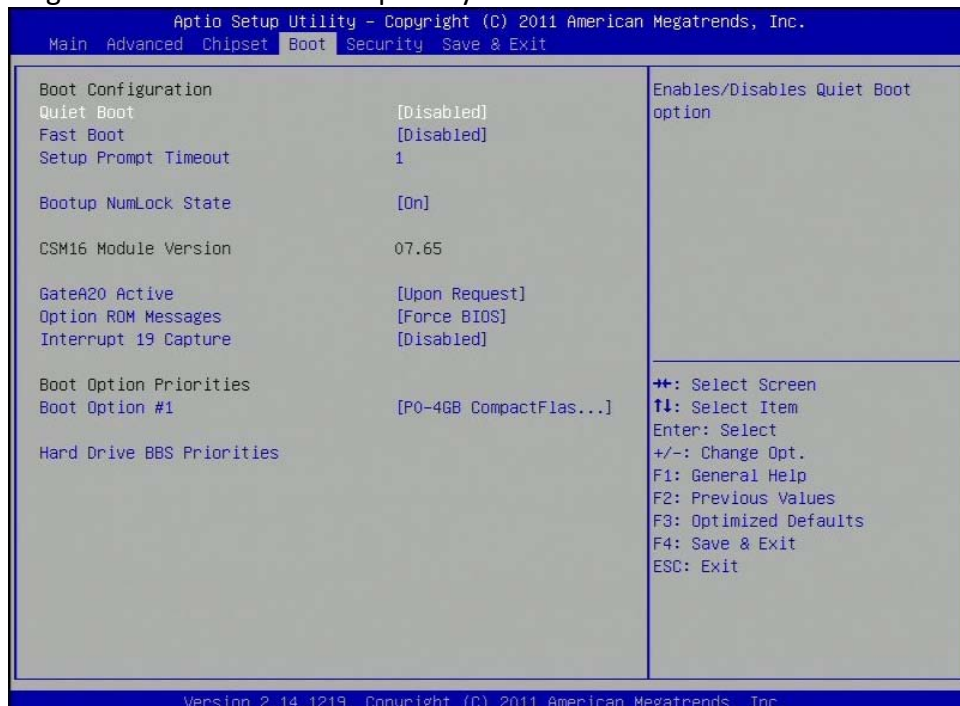

Quiet Boot

- Enabled Displays OEM logo instead of the POST messages.
- Disabled Displays normal POST messages.

Fast Boot

Enables or disables fast boot technology to speed up the system boot time. This is achieved by skipping specific tests during BIOS POST routine, there are VGA, USB, and PS2 to choose from.

Setup Prompt Timeout

Selects the number of seconds to wait for the setup activation key. 65535(0xFFFF) denotes indefinite waiting.

Bootup NumLock State

This function is used to set the state of the keyboard's numlock function after POST.

GateA20 Active

Upon Request	GA20 can be disabled using BIOS services
Always	Does not allow disabling GA20. This option is useful when an RT code is executed above 1M.

Option ROM Messages

Selects the display mode for Option ROM. The options are Force BIOS and Keep Current.

Interrupt 19 Capture

This function is used to specify if legacy PCI option ROMs are allowed to capture software interrupt 19h. Default setting: Disabled

4.7 Security

Select the Security tab to enter the Security Setup screen. This screen provides information about the passwords and functions for specifying the security settings.

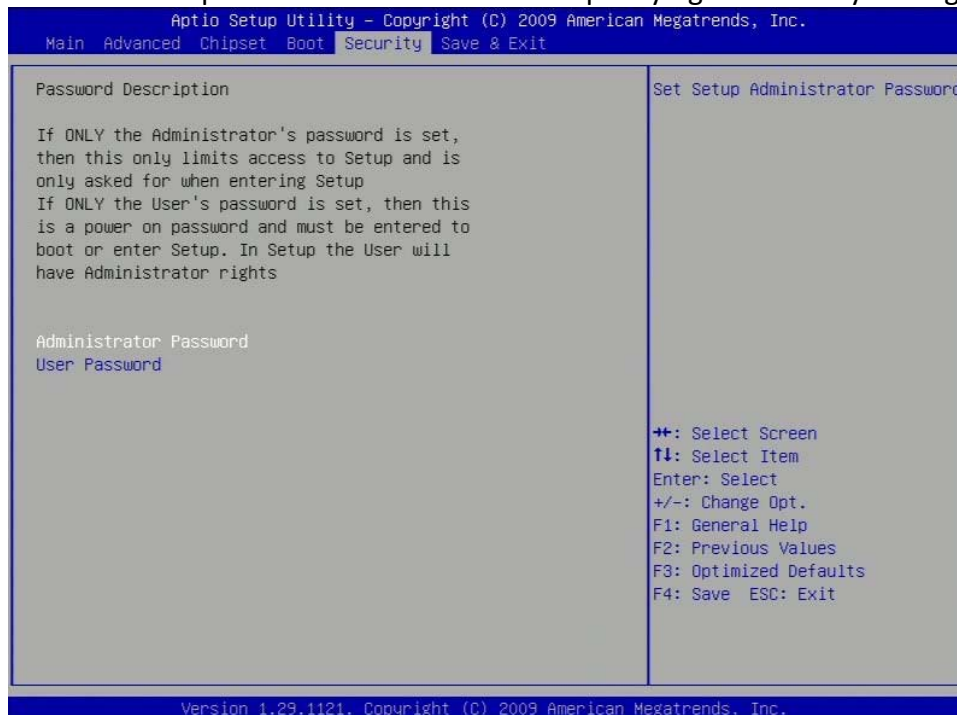

Administrator Password

Select this to reconfigure the administrator's password.

User Password

Select this to reconfigure the user's password.

4.8 Save and exit

Select the Save & Exit tab to enter the Save & Exit menu screen. This screen provides functions for handling changes made to BIOS settings and the exiting of the Setup program.

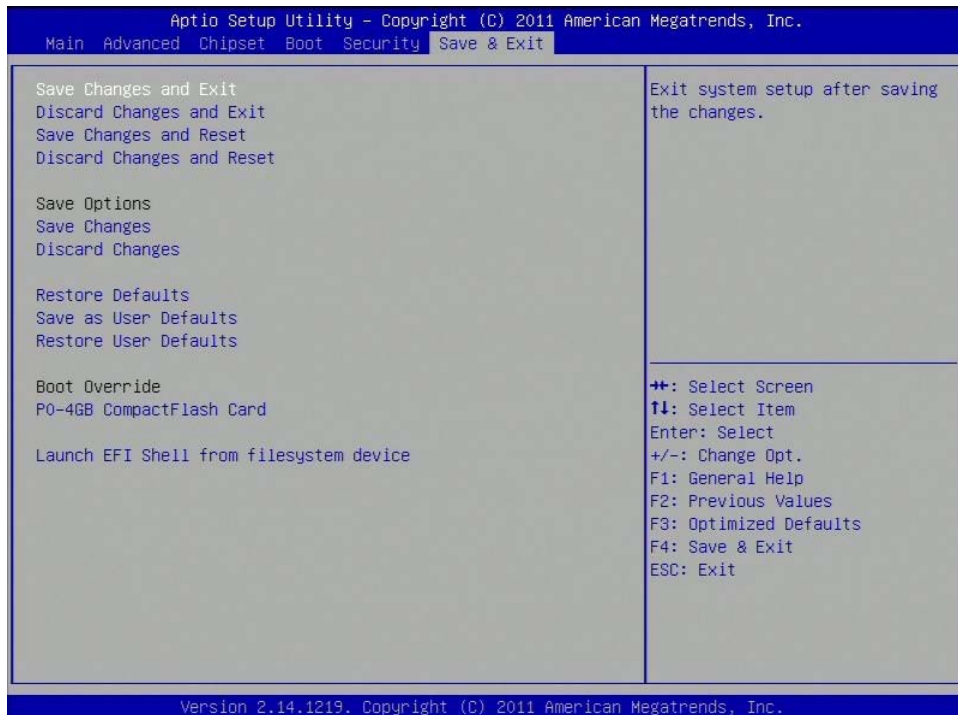

Save Changes and Exit

Exit system setup after saving the changes.

Disacard Changes and Exit

Exit system setup without saving any changes.

Save Changes and Reset

Reset the system after saving the changes.

Discard Changes and Reset

Reset system setup without saving any changes.

Save Options

This function is used to save all changes made within the Setup to Flash. This function returns to Setup.

Save Changes

Save Changes done so far to any of the setup options.

Discard Changes

Discard Changes done so far to any of the setup options.

Restore Defaults

Restore/Load Defaults values for all the setup options.

Save as User Defaults

Save the changes done so far as User Defaults.

Restore User Defaults

Restore the User Defaults to all the setup options.

Boot Override

Pressing ENTER causes the system to enter the OS.

Launch EFI Shell from filesystem device

To launch EFI shell from a file system device, select this field and press <Enter>.