

PER6760A

Perfect Box, Fanless Rugged System
User's Manual



Safety information

Electrical safety

- To prevent electrical shock hazard, disconnect the power cable from the electrical outlet before relocating the system.
- When adding or removing devices to or from the system, ensure that the power cables for the devices are unplugged before the signal cables are connected. If possible, disconnect all power cables from the existing system before you add a device.
- Before connecting or removing signal cables from the motherboard, ensure that all power cables are unplugged.
- Seek professional assistance before using an adapter or extension cord. These devices could interrupt the grounding circuit.
- Make sure that your power supply is set to the correct voltage in your area.
- If you are not sure about the voltage of the electrical outlet you are using, contact your local power company.
- If the power supply is broken, do not try to fix it by yourself. Contact a qualified service technician or your local distributor.

Operation safety

- Before installing the motherboard and adding devices on it, carefully read all the manuals that came with the package.
- Before using the product, make sure all cables are correctly connected and the power cables are not damaged. If you detect any damage, contact your dealer immediately.
- To avoid short circuits, keep paper clips, screws, and staples away from connectors, slots, sockets and circuitry.
- Avoid dust, humidity, and temperature extremes. Do not place the product in any area where it may become wet.
- Place the product on a stable surface.
- If you encounter any technical problems with the product, contact your local distributor

Statement

- All rights reserved. No part of this publication may be reproduced in any form or by any means, without prior written permission from the publisher.
- All trademarks are the properties of the respective owners.
- All product specifications are subject to change without prior notice

Revision History

Revision	Date (yyyy.mm.dd)	Changes
Version 1.0	2015.03.26	Initial release
Version 1.1	2017.08.21	Power type updated Photo updated

Packing list

- PER6760B-DP Fanless system
- CD (Driver + user's manual)
- Terminal block 3 PIN x 1pcs
- Wall mount bracket
- Screw

Optional Items

- CPU Processor
 - a. Intel® Core™ i7-3610QE Processor (6M Cache, 2.30 GHz), 45 W
 - b. Intel® Core™ i5-3610ME Processor (3M Cache, 2.70 GHz), 35W
 - c. Intel® Core™ i3-3120ME Processor (3M Cache, 2.40 GHz), 35W
- SO-DIMM
- SATA HDD/SSD
- 120W 19V 6.32A Switching Power Supply w/o power cord
- Thermal pad

Ordering information

Model Number	Description
PER6760A	Intel® QM77 Fanless Rugged System with Intel® Ivy Bridge Core™ i7/i5/i3 Processor, AMD E6760 GPU DPx4, 9V to 24V DC-in, Extended Temp. -20 to 60°C)
Processor	
Intel® Core™ i7-3610QE Processor (6M Cache, 2.30 GHz), 45W	
Intel® Core™ i5-3610ME Processor (3M Cache, 2.70GHz), 35W	
Intel® Core™ i3-3120ME Processor (3M Cache, 2.40 GHz), 35W	



If any of the above items is damaged or missing, please contact your local distributor.

Table Contents

SAFETY INFORMATION	1
ELECTRICAL SAFETY	1
OPERATION SAFETY	1
STATEMENT	1
REVISION HISTORY	2
PACKING LIST	2
OPTIONAL ITEMS	2
ORDERING INFORMATION	2
TABLE CONTENTS	3
CHAPTER 1: PRODUCT INFORMATION	5
1.1 KEY FEATURES.....	5
1.2 FRONT PANEL COMPONENTS.....	6
1.3 BACK PANEL COMPONENTS.....	6
1.4 MECHANICAL DRAWING	7
CHAPTER 2: CONNECTORS DEFINITION	8
Power Input: DC-in +9V~+24V	8
USB Port: USB2.0	8
COM2~COM3: RS232 with +12V/+5V selection	8
COM4: RS232	8
COM5: RS232/422/485.....	9
VGA: VGA.....	9
DVI-D: DVI-D	9
COM1: RS232/422/485 with +12V/+5V selection.....	10
HDMI: HDMI	10
LAN1_USB12: USB3.0 port 0,1 and LAN connector 1	11
LAN2_USB34: USB3.0 port 3,4 and LAN connector 2	11
Audio Lack	11
Display Port	12
CHAPTER 3: AMI BIOS UTILITY	13
3.1 STARTING.....	13
3.2 NAVIGATION KEYS	13
3.3 MAIN MENU	14
3.4 ADVANCED MENU	15
3.4.1 ACPI Settings.....	16
3.4.2 CPU Configuration	17
3.4.3 SATA Configuration	19
3.4.4 Thermal Configuration	20
3.4.4.1 Platform thermal configuration	20
3.4.5 Intel Rapid Start Technology	21
3.4.6 Intel TXT(LT) Configuration	21
3.4.7 PCH-FW Configuration.....	22
3.4.8 Intel Anti-Theft Technology Configuration.....	22
3.4.9 AMT Configuration	23
3.4.10 USB Configuration	25
3.4.11 F81866 Super IO Configuration	26
3.4.12 F81866 H/W Monitor	27
3.4.13 Serial Port Console Redirection.....	28
3.4.14 CPU PPM Configuration.....	29

- 3.5 CHIPSET 29
 - 3.5.1 PCH-IO Configuration 30
 - 3.5.1.1 USB Configuration 31
 - 3.5.1.2 PCH Azalia Configuration 32
 - 3.5.2 System Agent (SA) Configuration..... 33
 - 3.5.2.1 Graphics Configuration 34
 - 3.5.2.2 Memory Configuration 35
- 3.6 BOOT SETTING 36
- 3.7 SECURITY 37
- 3.8 SAVE AND EXIT 38

Chapter 1: Product Information

1.1 Key Features

Processor & System	
CPU Type	Intel® 22nm Ivy Bridge Processor (Mobile) socket (rPGA988) Core™ i7-3610QE 2.3 GHz (6M Cache, 45W) Core™ i5-3610ME 2.7 GHz (3M Cache, 35W) Core™ i3-3120ME 2.4 GHz (3M Cache, 35W)
Chipset	Intel® QM77
Memory Type	2 x 204-pin SO-DIMM support up to 16 GB dual channel DDR3 1333/1600, Non-ECC
Ethernet	Intel® 82579LM & 82574IT GbE LAN (support 10/100/1000Mbps for x2 RJ45 ports)
Storage Device	2 x 2.5" SATA HDD/SSD
Display	
Chipset	Integrated GFX in Ivy Bridge processor
Onboard VGA	1, (Max. resolution 1920 x 1200)
Onboard DVI-D	1, (Max. resolution 1920 x 1200)
Onboard HDMI	1, (Max. resolution 1920 x 1200)
DisplayPorts	4, (Max. resolution 2560 x 1600)
Independent Display Capability	VGA, DVI, HDMI, DisplayPort
Audio	
Codec	Realtek ALC892 High Definition Audio Codec
Front Panel I/O	
Power button	1
LED indicator	1 x Power LED, 1 x HDD LED
USB 2.0	4
COM2~5	2 x RS232/with 5V/12V by jumper selectable 1 x RS232 1 x RS232/422/485
Back Panel I/O	
Power IN	1 (3 pins terminal block)
VGA	1
DVI-D	1
COM1	1 (COM port, RS232/422/485 with 5V/12V by jumper selectable)
HDMI	1
LAN	2
USB3.0	4
Audio Jack	1 (Line-in, Line-out, MIC)
DisplayPort	4
Mechanical and Environment	
Power Type	9V to 24V DC-in
Dimension	370 x 160.6 x 245.03 mm
Storage Temp.	-20 to 80°C
Operating Temp.	-20 to 60°C
Relative Humidity	10% to 90%, non-condensing

*All specifications and photos are subject to change without notice.

1.2 Front Panel Components

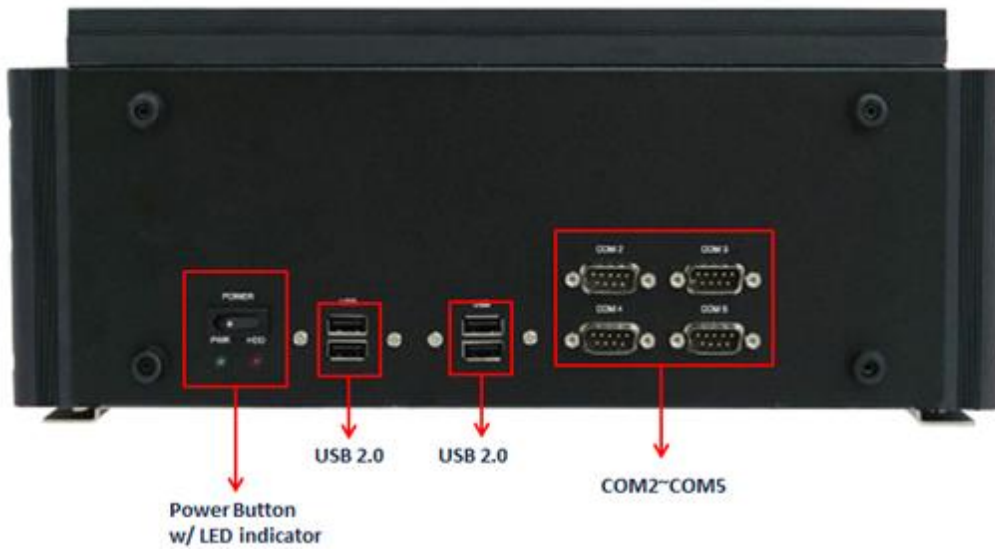

1.3 Back Panel Components

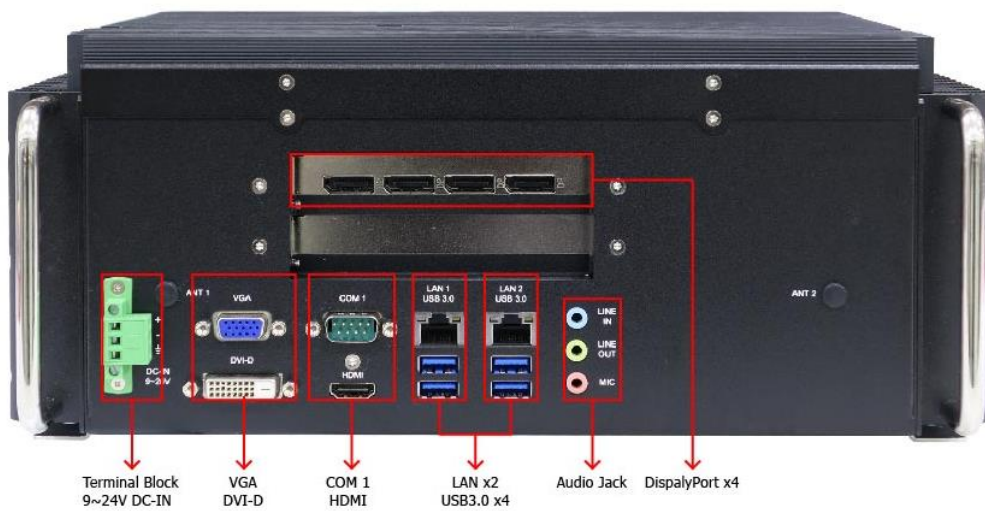

1.4 Mechanical Drawing

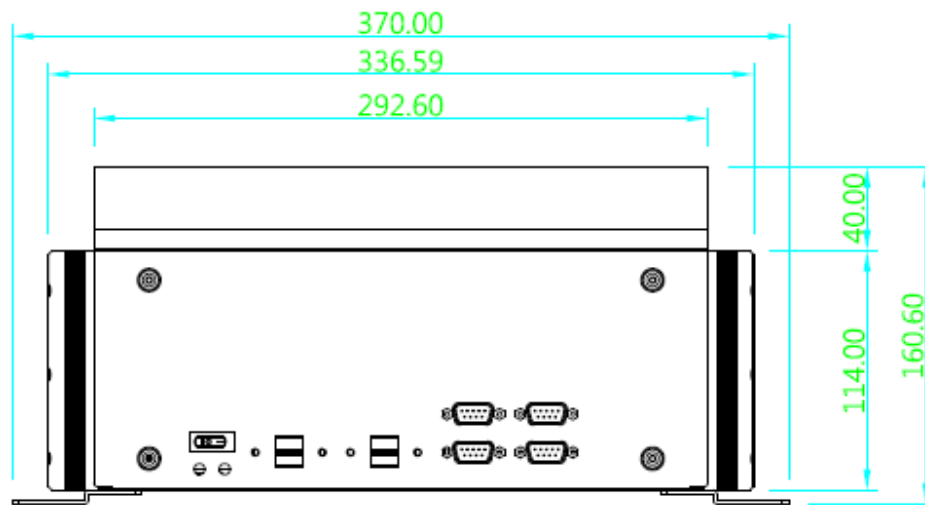

Front

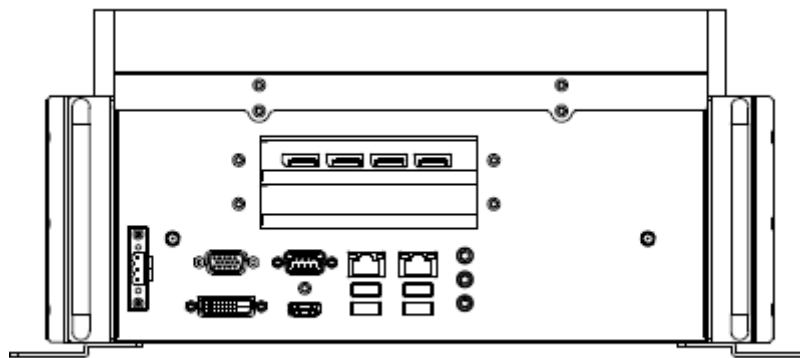

Back



Right

Chapter 2: Connectors definition

Power Input: DC-in +9V~+24V

PIN	DEFINITION
1	+9V~+24V
2	-
3	GND

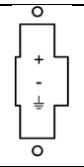

USB Port: USB2.0

PIN	DEFINITION	PIN	DEFINITION
1	+5V	5	+5V
2	USBD-	6	USBD-
3	USBD+	7	USBD+
4	GND	8	GND

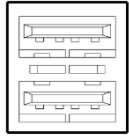

COM2~COM3: RS232 with +12V/+5V selection

PIN	DEFINITION	PIN	DEFINITION
1	DCD-	2	RXD
3	TXD	4	DTR-
5	GND	6	DSR-
7	RTS-	8	CTS-
9	COM2P9SEL/ COM3P9SEL (Define by JP6/7)		

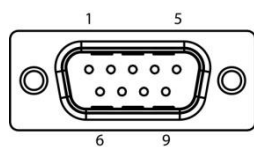

COM4: RS232

PIN	DEFINITION	PIN	DEFINITION
1	DCD-	2	RXD
3	TXD	4	DTR-
5	GND	6	DSR-
7	RTS-	8	CTS-
9	RI-		



COM5: RS232/422/485

PIN	RS-232	RS-422	HALF DUPLEX RS-485
1	DCD-	TX-	DATA-
2	RXD	RX+	NA
3	TXD	TX+	DATA+
4	DTR-	RX-	NA
5	GND	GND	GND
6	DSR-	NA	NA
7	RTS-	NA	NA
8	CTS-	NA	NA
9	RI-	RI-	RI-

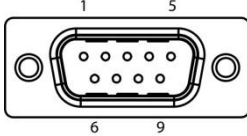

VGA: VGA

PIN	DEFINITION	PIN	DEFINITION
1	RED	9	+5V
2	GREEN	10	GND
3	BLUE	11	NC
4	NC	12	DDC DATA
5	GND	13	HSYNC
6	GND	14	VSYNC
7	GND	15	DDC CLOCK
8	GND		

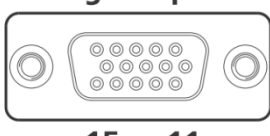

DVI-D: DVI-D

PIN	DEFINITION	PIN	DEFINITION
1	TMDS2-	13	NC
2	TMDS2+	14	+5V
3	GND	15	GND
4	NC	16	HOTPLUG_DETECT
5	NC	17	TMDS0-
6	DDC_CLK	18	TMDS0+
7	DDC_DATA	19	GND
8	NC	20	NC
9	TMDS1-	21	NC
10	TMDS1+	22	GND
11	GND	23	TMDSCLK+
12	NC	24	TMDSCLK-

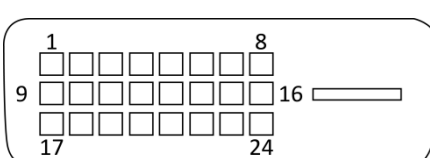

COM1: RS232/422/485 with +12V/+5V selection

PIN	RS-232	RS-422	HALF DUPLEX RS-485
1	DCD-	TX-	DATA-
2	RXD	RX+	NA
3	TXD	TX+	DATA+
4	DTR-	RX-	NA
5	GND	GND	GND
6	DSR-	NA	NA
7	RTS-	NA	NA
8	CTS-	NA	NA
9	COM1P9SEL (Define by JP5)	COM1P9SEL (Define by JP5)	COM1P9SEL (Define by JP5)

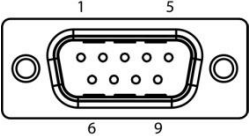

HDMI: HDMI

PIN	DEFINITION	PIN	DEFINITION
1	HDMI_2P	11	GND
2	GND	12	HDMI_CLKN
3	HDMI_2N	13	NC
4	HDMI_1P	14	NC
5	GND	15	DDC CLOCK
6	HDMI_1N	16	DDC DATA
7	HDMI_OP	17	GND
8	GND	18	+5V
9	HDMI_ON	19	HOTPLUG_DETECT
10	HDMI_CLKP		

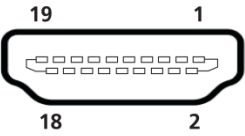

LAN1_USB12: USB3.0 port 0,1 and LAN connector 1

LAN2_USB34: USB3.0 port 3,4 and LAN connector 2

UPPER USB		LOWER USB		LAN	
PIN	DEFINITION	PIN	DEFINITION	PIN	DEFINITION
1	+5VDUAL	1	+5VDUAL	1	D0+
2	D-	2	D-	2	D0-
3	D+	3	D+	3	D1+
4	GND	4	GND	4	D1-
5	StdA_SSTX-	5	StdA_SSTX-	5	D2+
6	StdA_SSTX+	6	StdA_SSTX+	6	D2-
7	GND_DRIAN	7	GND_DRIAN	7	D3+
8	StdA_SSRX-	8	StdA_SSRX-	8	D3-
9	StdA_SSRX-	9	StdA_SSRX-		
SPEED LED: (LEFT)		ACTIVE LED: (RIGHT)			
GREEN: 1000Mbps		ORANGE (BLINKING): ACTIVITY			
ORANGE: 100Mbps		No Light: NOT LINK			
No Light: 10Mbps		ORANGE (NO BLINKING): LINK			

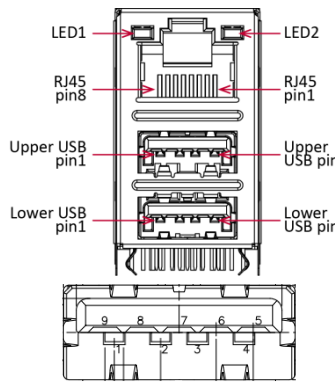
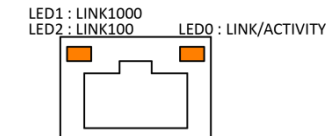
Audio Jack

Pin	Definition
A1	LINE-IN_L
A2	LINE-IN_JD
A3	AGND
A4	LINE-IN_R
B1	LINE-OUT_L
B2	LINE-OUT_JD
B3	AGND
B4	LINE-OUT_R
C1	MIC_L
C2	MIC_JD
C3	AGND
C4	MIC_R
C0	AGND

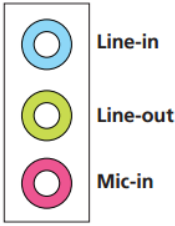

Display Port

Pin	Definition
1	ML_Lane 0(p)
2	GND
3	ML_Lane 0(n)
4	ML_Lane 1(p)
5	GND
6	ML_Lane 1(n)
7	ML_Lane 2(p)
8	GND
9	ML_Lane 2(n)
10	ML_Lane 3(p)
11	GND
12	ML_Lane 3(n)
13	GND
14	GND
15	AUX_CH(p)
16	GND
17	AUX_CH(n)
18	Hot Plug
19	DP_PWR Return
20	DP_PWR

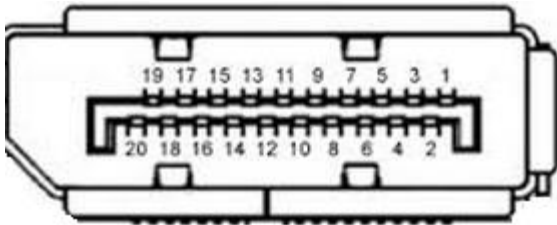

Chapter 3: AMI BIOS UTILITY

This chapter provides users with detailed descriptions on how to set up a basic system configuration through the AMI BIOS setup utility.

3.1 Starting

To enter the setup screens, perform the following steps:

- Turn on the computer and press the key immediately.
- After the key is pressed, the main BIOS setup menu displays. Other setup screens can be accessed from the main BIOS setup menu, such as the Chipset and Power menus.

3.2 Navigation Keys

The BIOS setup/utility uses a key-based navigation system called hot keys. Most of the BIOS setup utility hot keys can be used at any time during the setup navigation process.

Some of the hot keys are <F1>, <F10>, <Enter>, <ESC>, and <Arrow> keys.



Some of the navigation keys may differ from one screen to another.

Left/Right	The Left and Right <Arrow> keys moves the cursor to select a menu.
Up/Down	The Up and Down <Arrow> keys moves the cursor to select a setup screen or sub-screen.
+– Plus/Minus	The Plus and Minus <Arrow> keys changes the field value of a particular setup setting.
Tab	The <Tab> key selects the setup fields.
F1	The <F1> key displays the General Help screen.
F10	The <F10> key saves any changes made and exits the BIOS setup utility.
Esc	The <Esc> key discards any changes made and exits the BIOS setup utility.
Enter	The <Enter> key displays a sub-screen or changes a selected or highlighted option in each menu.

3.3 Main Menu

The Main menu is the first screen that you will see when you enter the BIOS Setup Utility.

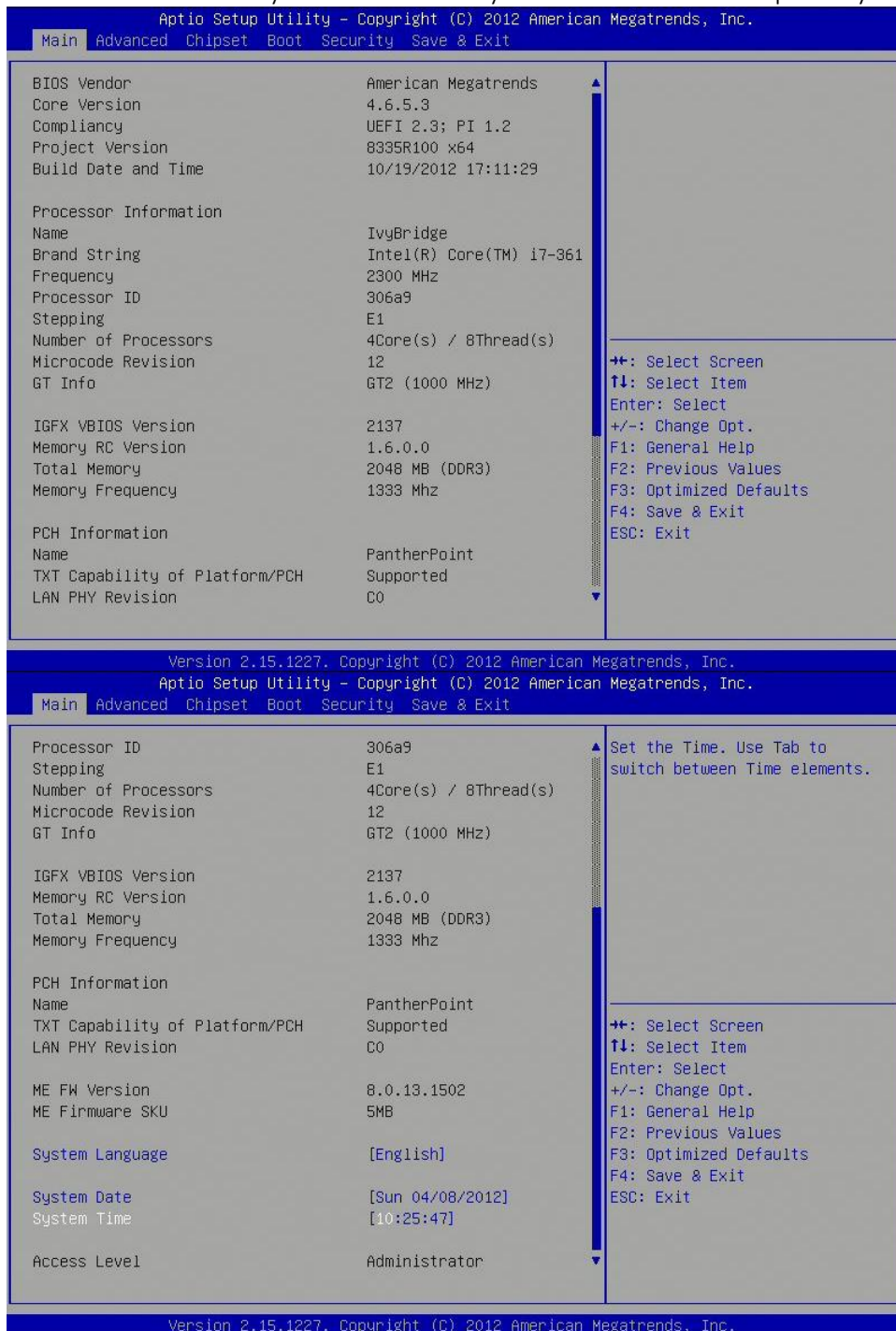

System Language

Use this function to select the system language.

System Date

Use this function to change the system date.

Select System Date using the Up and Down <Arrow> keys. Enter the new values through the keyboard. Press the Left and Right <Arrow> keys to move between fields.

The date setting must be entered in MM/DD/YY format.

System Time

Use this function to change the system time.

Select System Time using the Up and Down <Arrow> keys. Enter the new values through the keyboard. Press the Left and Right <Arrow> keys to move between fields.

The time setting is entered in HH:MM:SS format.

Note: The time is in 24-hour format. For example, 5:30 A.M. appears as 05:30:00, and 5:30 P.M. as 17:30:00.

Access Level

Displays the access level of the current user in the BIOS.

3.4 Advanced Menu

The Advanced Menu allows you to configure your system for basic operation. Some entries are defaults required by the system board, while others, if enabled, will improve the performance of your system or let you set some features according to your preference. **Setting incorrect field values may cause the system to malfunction.**

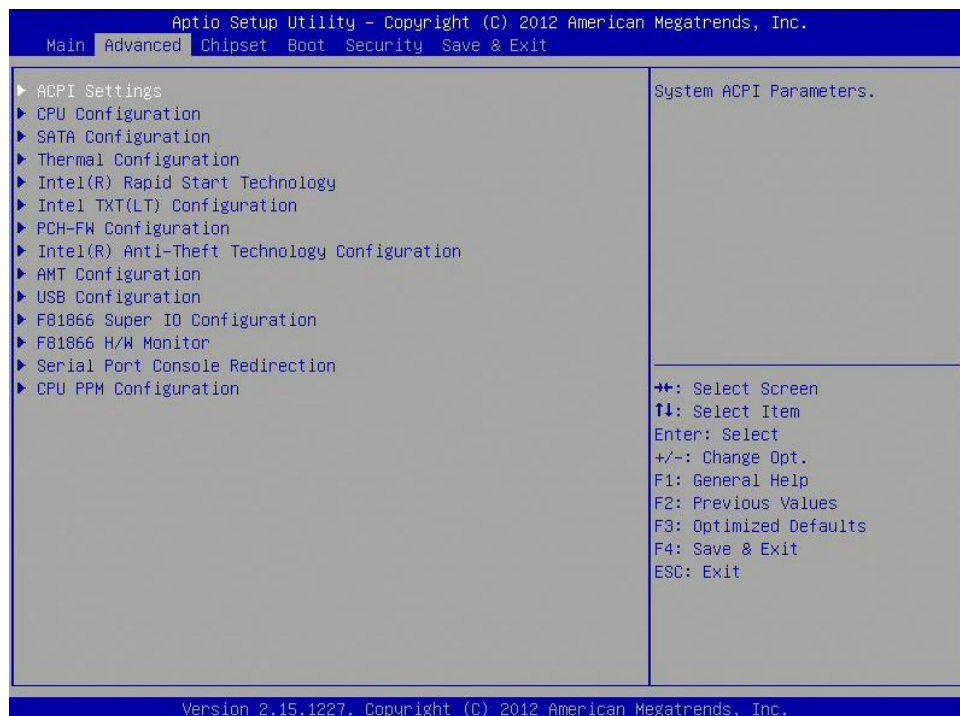

3.4.1 ACPI Settings

System ACPI parameters

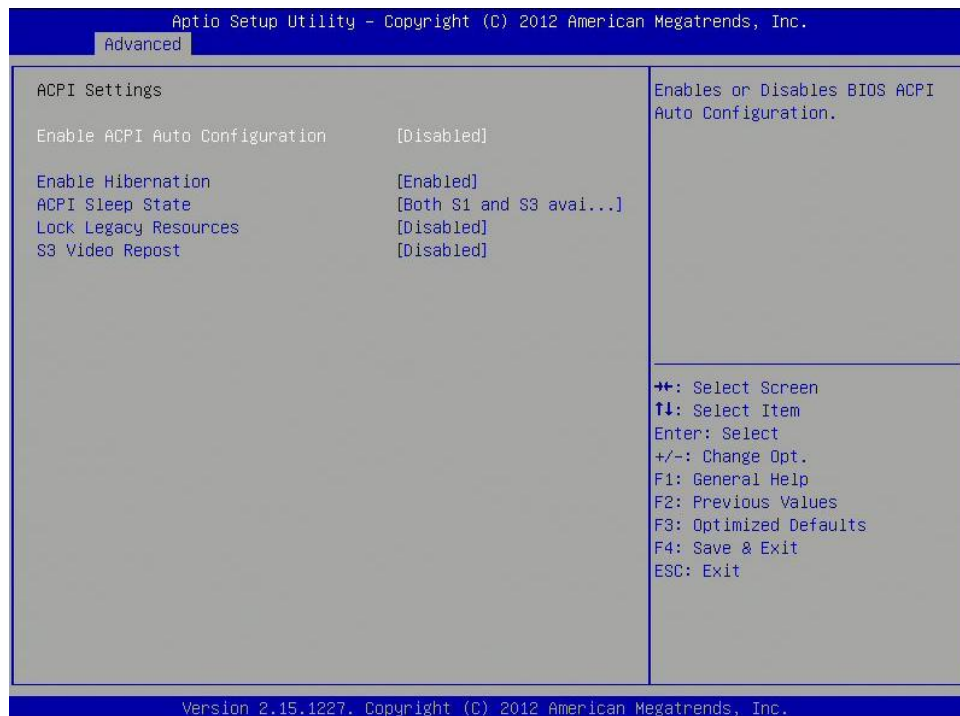

Enable ACPI Auto Configuration

Enables or disables BIOS ACPI auto configuration.

Enable Hibernation

Enables or disables system ability to hibernate (OS/S4 Sleep State). This option may not be effective with some OS.

ACPI Sleep State

Select the ACPI sleep state the system will enter when the suspend button is pressed.

Lock Legacy Resources

Enables or Disables System Lock of Legacy Resources.

S3 Video Repost

Enable or disable S3 Video Repost.

3.4.2 CPU Configuration

This section is used to configure the CPU.

Aptio Setup Utility - Copyright (C) 2012 American Megatrends, Inc.

Advanced

CPU Configuration		Enabled for Windows XP and Linux (OS optimized for Hyper-Threading Technology) and Disabled for other OS (OS not optimized for Hyper-Threading Technology). When Disabled only one thread per enabled core is enabled. ++: Select Screen ↑↓: Select Item Enter: Select +/-: Change Opt. F1: General Help F2: Previous Values F3: Optimized Defaults F4: Save & Exit ESC: Exit
Intel(R) Core(TM) i7-3610QE CPU @ 2.30GHz		
CPU Signature	306a9	
Microcode Patch	12	
Max CPU Speed	2300 MHz	
Min CPU Speed	1200 MHz	
CPU Speed	2300 MHz	
Processor Cores	4	
Intel HT Technology	Supported	
Intel VT-x Technology	Supported	
Intel SMX Technology	Supported	
64-bit	Supported	
L1 Data Cache	32 KB x 4	
L1 Code Cache	32 KB x 4	
L2 Cache	256 KB x 4	
L3 Cache	6144 KB	
Hyper-threading	[Enabled]	
Active Processor Cores	[All]	
Limit CPUID Maximum	[Disabled]	
Execute Disable Bit	[Enabled]	
Intel Virtualization Technology	[Enabled]	
Hardware Prefetcher	[Enabled]	

Version 2.15.1227. Copyright (C) 2012 American Megatrends, Inc.

Aptio Setup Utility - Copyright (C) 2012 American Megatrends, Inc.

Advanced

Microcode Patch		The Maximum instantaneous current allow for Secondary Plane ++: Select Screen ↑↓: Select Item Enter: Select +/-: Change Opt. F1: General Help F2: Previous Values F3: Optimized Defaults F4: Save & Exit ESC: Exit
Max CPU Speed	2300 MHz	
Min CPU Speed	1200 MHz	
CPU Speed	2300 MHz	
Processor Cores	4	
Intel HT Technology	Supported	
Intel VT-x Technology	Supported	
Intel SMX Technology	Supported	
64-bit	Supported	
L1 Data Cache	32 KB x 4	
L1 Code Cache	32 KB x 4	
L2 Cache	256 KB x 4	
L3 Cache	6144 KB	
Hyper-threading	[Enabled]	
Active Processor Cores	[All]	
Limit CPUID Maximum	[Disabled]	
Execute Disable Bit	[Enabled]	
Intel Virtualization Technology	[Enabled]	
Hardware Prefetcher	[Enabled]	
Adjacent Cache Line Prefetch	[Enabled]	
TDC Activation offset	10	
Primary Plane Current value	0	
Secondary Plane Current value	0	

Version 2.15.1227. Copyright (C) 2012 American Megatrends, Inc.

Hyper-threading

Enabled for Windows XP and Linux (OS optimized for Hyper-Threading Technology) and Disabled for other OS (OS not optimized for Hyper-Threading Technology). When disabled only one thread per enabled core is enabled.

Active Processor Cores

Number of cores to enable in each processor package.

Limit CPUID Maximum

Disabled for Windows XP.

Execute Disable Bit

XD can prevent certain classes of malicious buffer overflow attacks when combined with a supporting OS (Windows Sever 2003 SP1, Windows XP SP2, SuSE Linux 9.2, RedHat Enterprise 3 Update 3.)

Intel Virtualization Technology

When enabled, a VMM can utilize the additional hardware capabilities provided by Vanderpool Technology.

Hardware Prefetcher

To turn on/off the Mid Level Cache (L2) streamer prefetcher

Adjacent Cache Line Prefetcher

To turn on/off prefetching of adjacent cache lines

TCC Activation Offset

Offset from the factory TCC activation temperature

Primary Plane Current Value

The Maximum instantaneous current allow for primary plane

Secondary Plane Current Value

The Maximum instantaneous current allow for secondary plane

3.4.3 SATA Configuration

This section is used to configure the SATA drives.

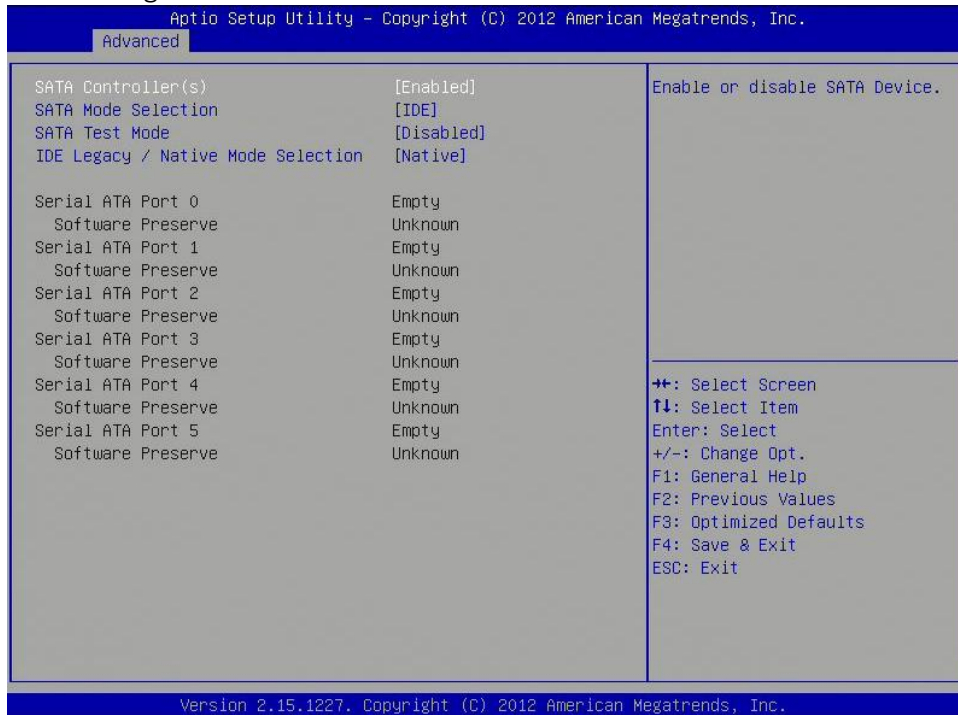

SATA Controller(s)

Enable or disable SATA device.

SATA Mode Selection

Determines how SATA controller(s) operate.

SATA Test Selection

Enable or disable Test Mode

IDE Legacy/Native Mode Selection

IDE Legacy/Native Mode Selection

Serial ATA Port 0 – 5

Displays information on the SATA devices detected

3.4.4 Thermal Configuration

Platform thermal configuration options

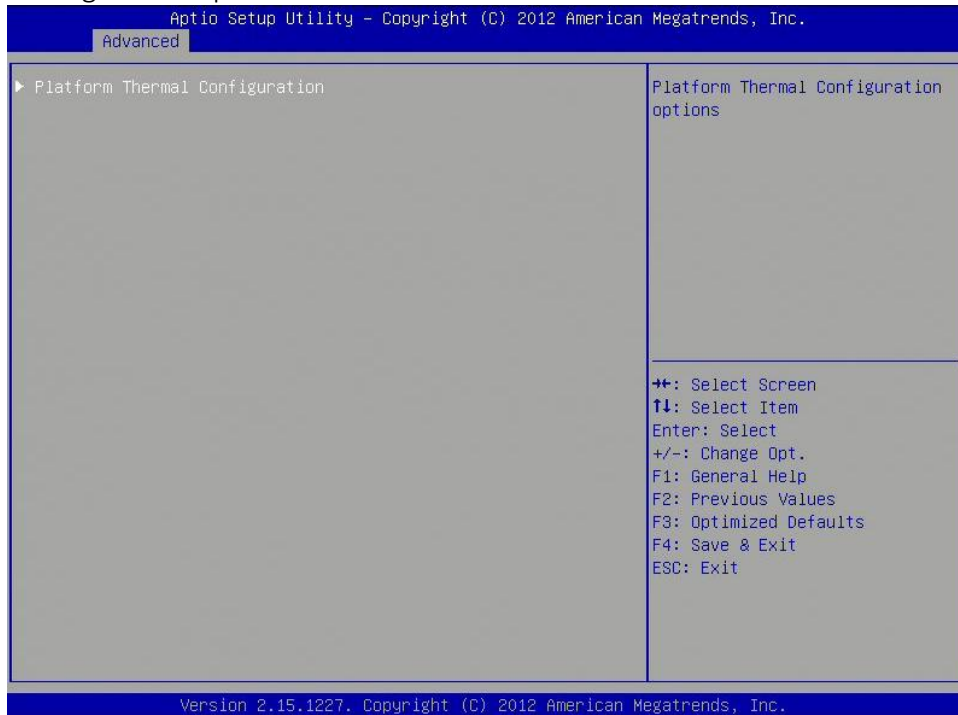

3.4.4.1 Platform thermal configuration



3.4.5 Intel Rapid Start Technology



3.4.6 Intel TXT(LT) Configuration

Intel Trusted Execution Technology

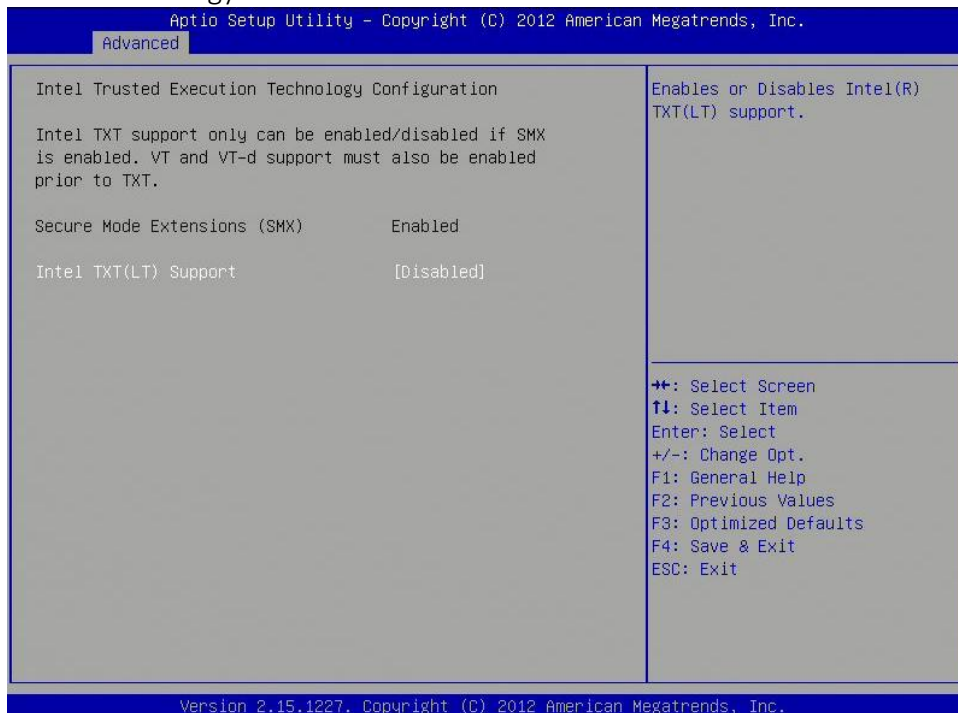

Intel TXT(LT) Support

Enables or disables Intel TXT(LT) support

3.4.7 PCH-FW Configuration

This section is used to configure Management Engine Technology parameters.

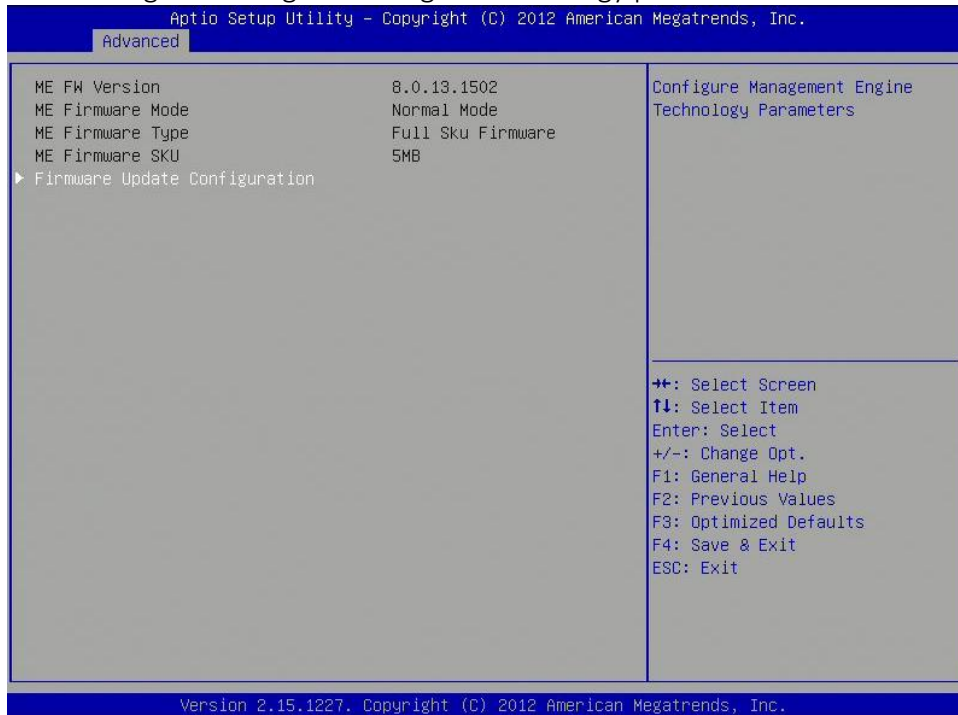

3.4.8 Intel Anti-Theft Technology Configuration

Disabling Intel AT allow user to login platform. This is strictly for testing only. This does not disable Intel AT services in ME



Intel Anti-Theft Technology

Enable or Disable Intel AT in BIOS for testing only

Intel Anti-Theft Technology Rec

Set the number of times Recovery attempted will be allowed.

3.4.9 AMT Configuration

This section is used to configure Active Management Technology (AMT) options.

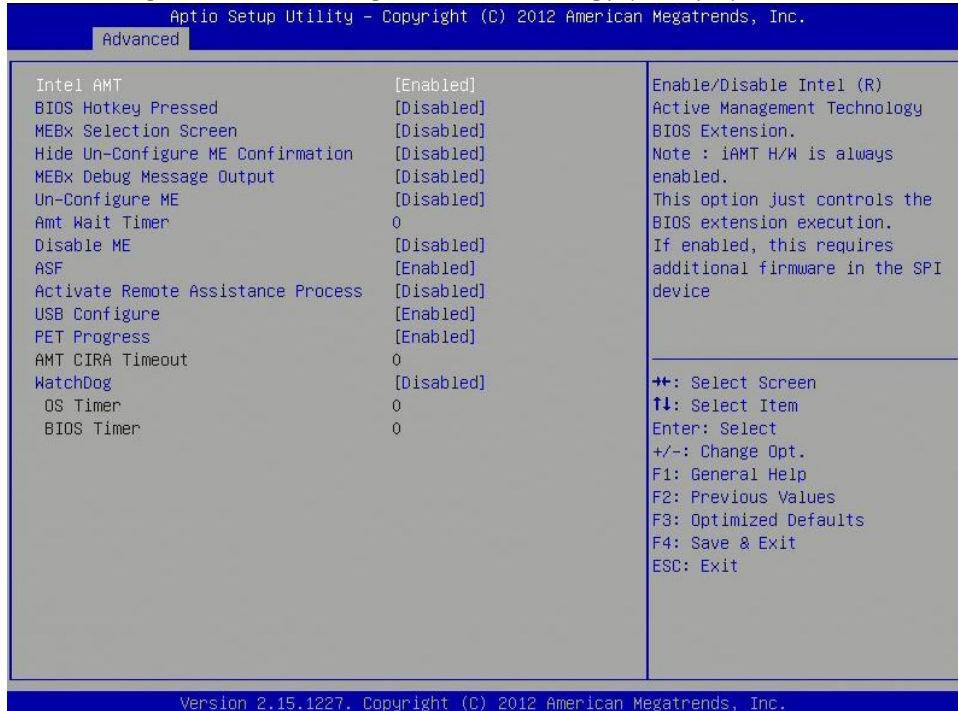

Intel AMT

Enable/disable Intel Active Management Technology BIOS extension.

Note: iAMT H/W is always enabled.

This option just controls the BIOS extension execution. If enabled, this requires additional firmware in the SPI device.

BIOS Hotkey Pressed

Enable/disable BIOS hotkey press.

MEBx Selection Screen

Enable/disable MEBx Selection Screen

Hide Un-Configure ME Confirmation

Hide Un-Configure ME without password confirmation prompt

MEBx Debug Message Screen

Enable MEBx debug message output

Un-Configure ME

Perform AMT/ME unconfigure without password operation.

Amt Wait Timer

Set timer to wait before sending ASF_GET_BOOT_OPTIONS.

Disable ME

Set ME to Soft Temporary Disabled

ASF

Enable/Disable Alert specification Format

Activate Remote Assistance Process

Trigger CIRA boot.

USB Configure

Enable/Disable USB configure function.

PET Progress

User can Enable/Disable PET Events progress to receive PET events or not.

Watchdog Timer

Enable/Disable Watchdog Timer.

3.4.10 USB Configuration

This section is used to configure the USB

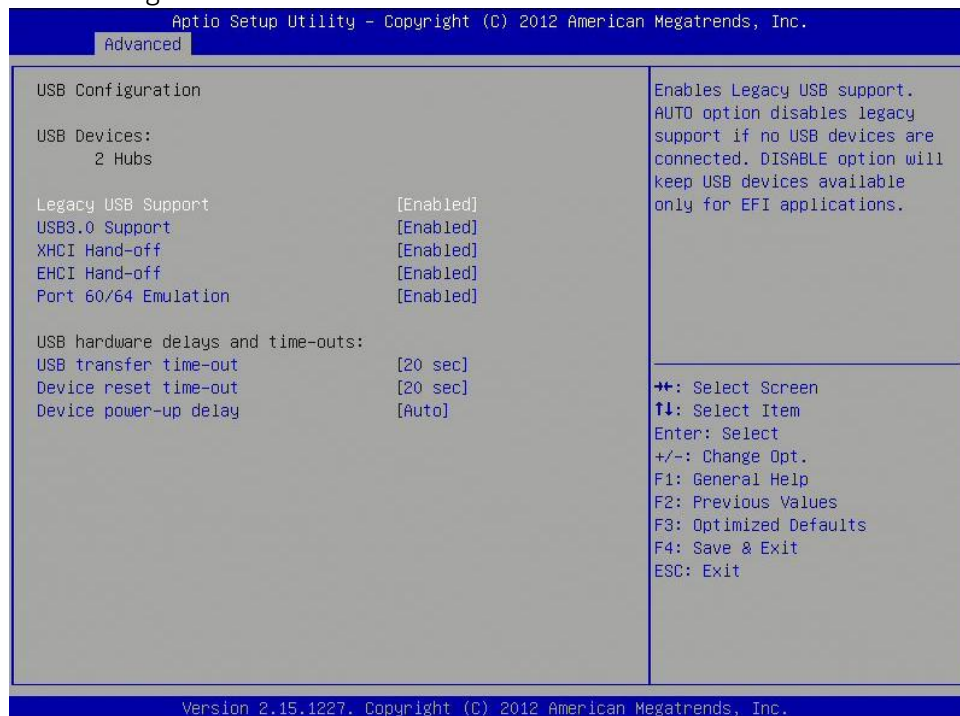

Legacy USB Support

Enables Legacy USB support.

AUTO option disables legacy support if no USB devices are connected.

DISABLE option will keep USB devices available only for EFI applications.

USB3.0 Support

Enable/Disable USB3.0 (XHCI) Controller support.

XHCI Hand-off

This is a workaround for OSES without XHCI hand-off support. The XHCI ownership change should be claimed by XHCI driver.

EHCI Hand-off

This is a workaround for OSES without EHCI hand-off support. The EHCI ownership change should be claimed by EHCI driver.

Port 64/60 Emulation

Enables I/O port 60h/64h emulation support. This should be enabled for the complete USB keyboard legacy support for non-USB aware OSES.

USB Transfer time-out

The time-out value for Control, Bulk, and Interrupt transfers.

Device reset time-out

USB mass Storage device start Unit command time-out.

Device power-up delay

Maximum time the device will take before it properly reports itself to the Host Controller. 'Auto' uses default value: for a Root port it is 100ms, for a Hub port the delay is taken from Hub descriptor.

3.4.11 F81866 Super IO Configuration

System super IO chip parameters

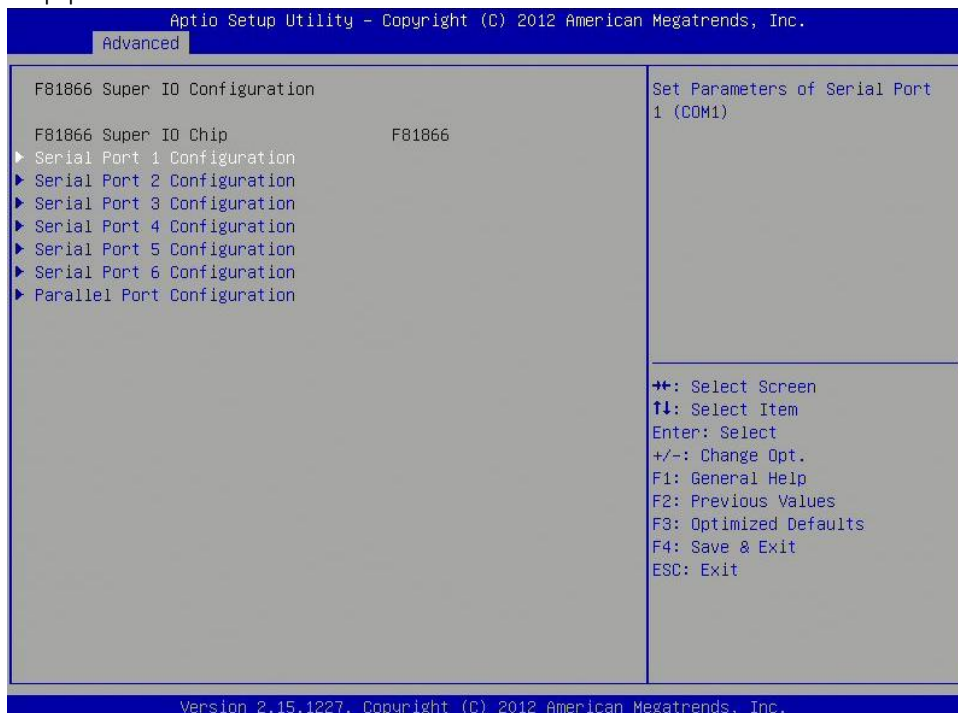
**Serial Port Configuration**

Set Parameters of Serial Ports. User can Enable/Disable the serial port and Select an optimal settings for the Super IO Device.

Parallel Port configuration

Set parameters of parallel port (LPT/LPTE)

3.4.12 F81866 H/W Monitor

This section is used to monitor hardware status such as temperature, fan speed and voltages.

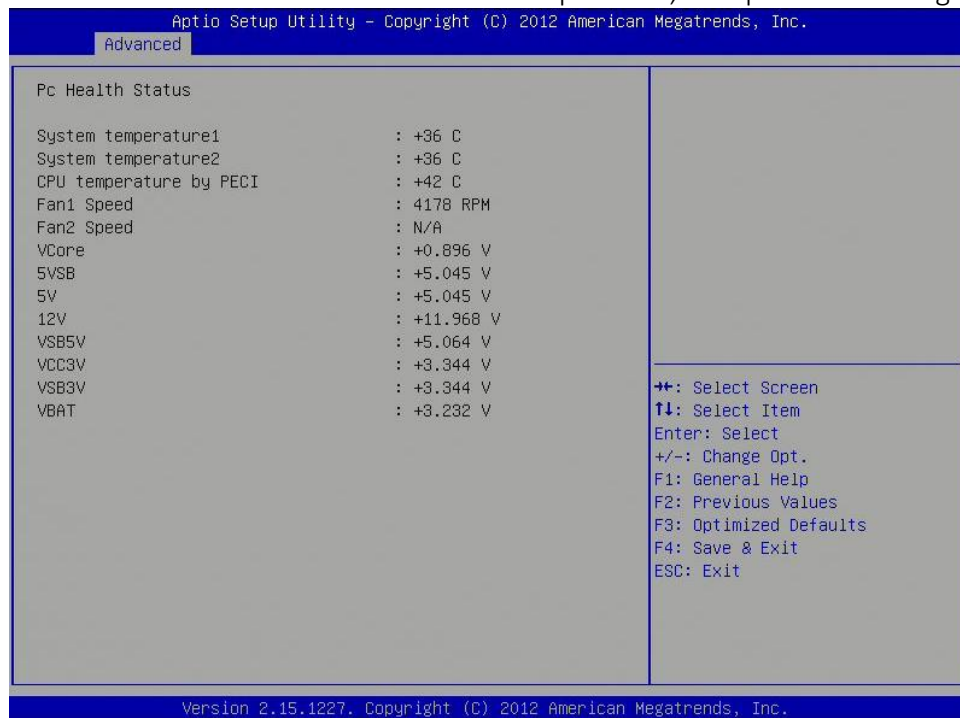

System Temperature

Detects and displays the current system temperature.

CPU Temperature

Detects and displays the current CPU temperature.

Fan1/2 Speed

Detects and displays the current CPU fan speed.

3.4.13 Serial Port Console Redirection

This screen provides information about functions for specifying the Serial Port Console Redirection configuration settings. Console redirection can be used to remotely operate system settings and the EFI console.

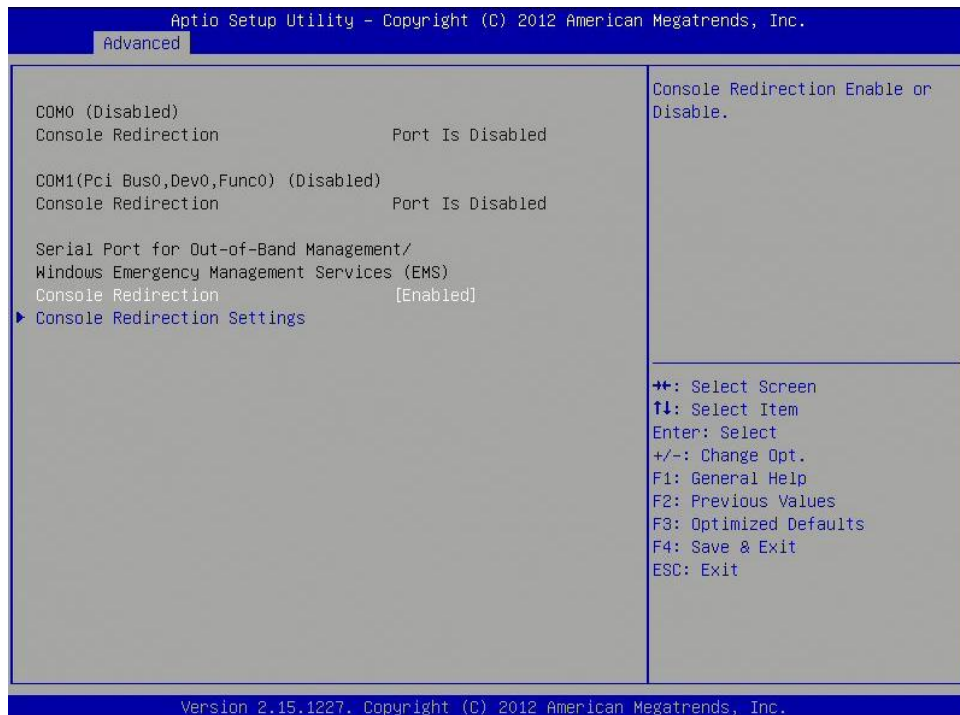

Console Redirection

Console Redirection Enable or Disable.

Console Redirection Settings

The setting specify how the host computer and the remote computer (which the user is using) will exchange data. Both computers should have the same or compatible settings.

3.4.14 CPU PPM Configuration

CPU PPM configuration parameters

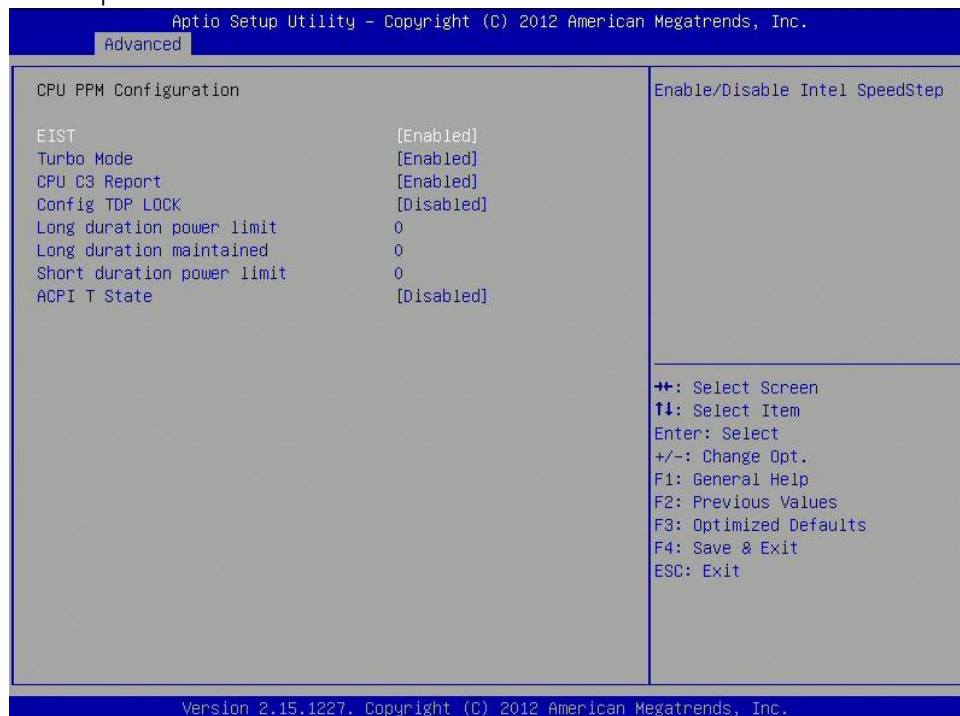

EIST

Enables or disables Intel SpeedStep.

CPU C3 Report

Enable or disable CPU C3 (ACPI C2) report to OS.

Config TDP LOCK

Lock the Config TDP control register

Long duration power limit

Long duration power limit in Watts, 0 means use factory default.

Long duration maintained

Time window which the long duration power is maintained.

Short duration power limit

Short duration power limit in Watts, 0 means use factory default.

ACPI T State

Enable or disable ACPI state support.

3.5 Chipset

This section gives you functions to configure the system based on the specific features of the chipset. The chipset manages bus speeds and access to system memory resources.



3.5.1 PCH-IO Configuration

This section allows you to configure the North Bridge Chipset.



USB Configuration

USB configuration settings

PCH Azalia Configuration

PCH Azalia configuration settings

PCH LAN Controller

Enable or disable onboard NIC.

Wake on LAN

Enable or disable integrated LAN to wake the system. (The Wake On LAN cannot be disabled if ME is on at Sx state.)

PCIE LAN Controller

Enable or disable onboard PCIE LAN

Wireless LAN Controller

Enable or disable onboard MPCIE LAN-Wireless LAN.

SLP_S4 Assertion Width

Select a minimum assertion width of the SLP_S4# signal.

Restore AC Power Loss

Select AC power state when power is re-applied after a power failure.

RI Wake Up

RI wake up function select.

Watch Dog Function select

Watch Dog function enabled or disabled.

3.5.1.1 USB Configuration



XHCI Pre-Boot Driver

Enable or disable XHCI Pre-Boot driver support.

XHCI Mode

Mode of operation of XHCI controller

HS Port #1/2/3/4 Switchable

Allows for HS port switching between xHCI and EHCI. If disabled, port is routed to EHCI. If HS port is routed to xHCI, the corresponding SS port is enabled.

xHCI Streams

Enable or disable xHCI Maximum Primary Stream Array Size.

EHCI1/2

Control the USB EHCI (USB 2.0) functions. One EHCI controller must always be enabled.

USB Ports Per-Port Disable Control

Control each of the USB ports (0~13) disabling.

3.5.1.2 PCH Azalia Configuration

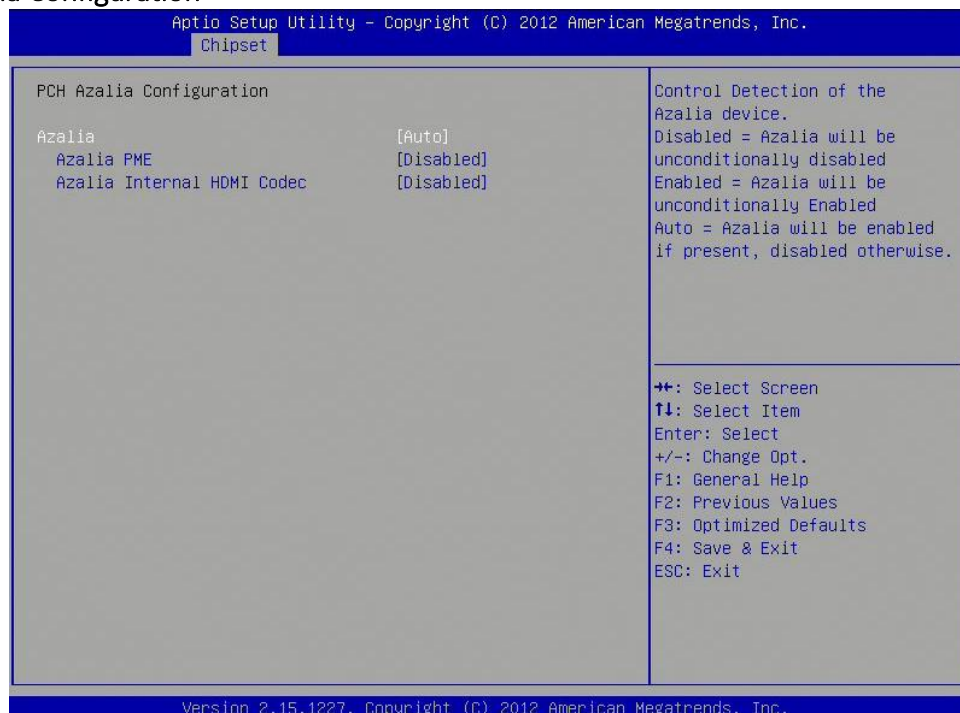

Azalia

Control Detection of the Azalia device.

Disabled=Azalia will unconditionally disabled.

Enabled=Azalia will be unconditionally enabled.

Auto=Azalia will enabled if present, disabled otherwise.

Azalia PME

Enable or disable Power Management capability of audio controller.

Azalia Internal HDMI codec

Enable or disable internal HDMI codec for Azalia.

3.5.2 System Agent (SA) Configuration

This section is used to configure the System Agent (SA) configuration.

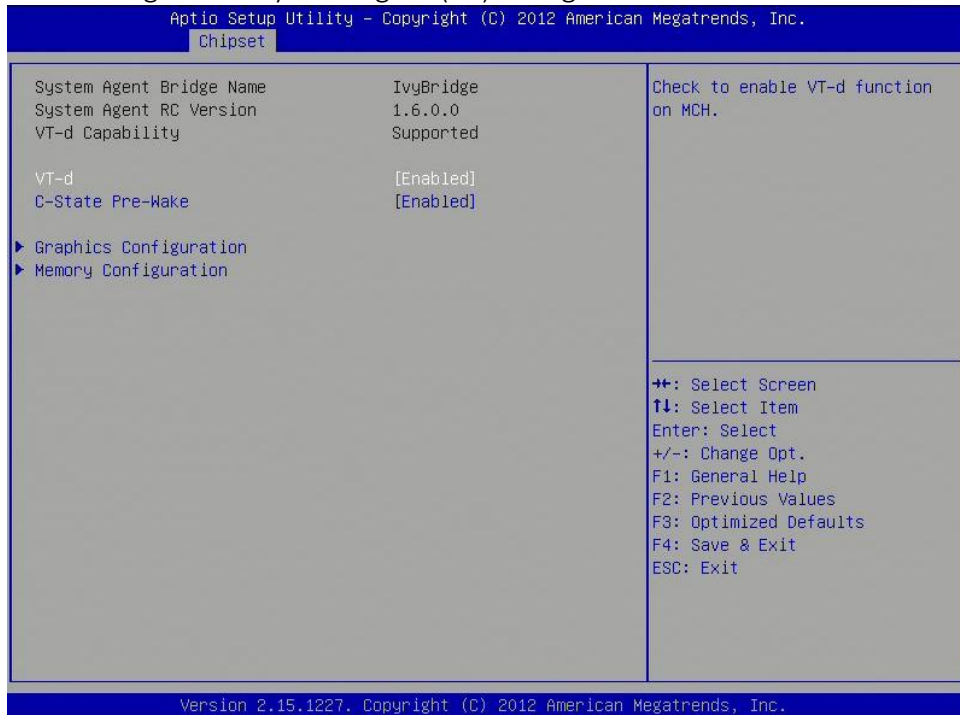

VT-d

- Check to enable VT-d function on MCH.
- Enable NB CRID
- Enable or disable NB CRID WorkAround.

C-State Pre-Wake

Controls C-State Pre-Wake feature for ARAT, in SSKPD[57].

Graphics Configuration

Configure graphics settings

Memory Configuration

Memory configuration parameters

3.5.2.1 Graphics Configuration

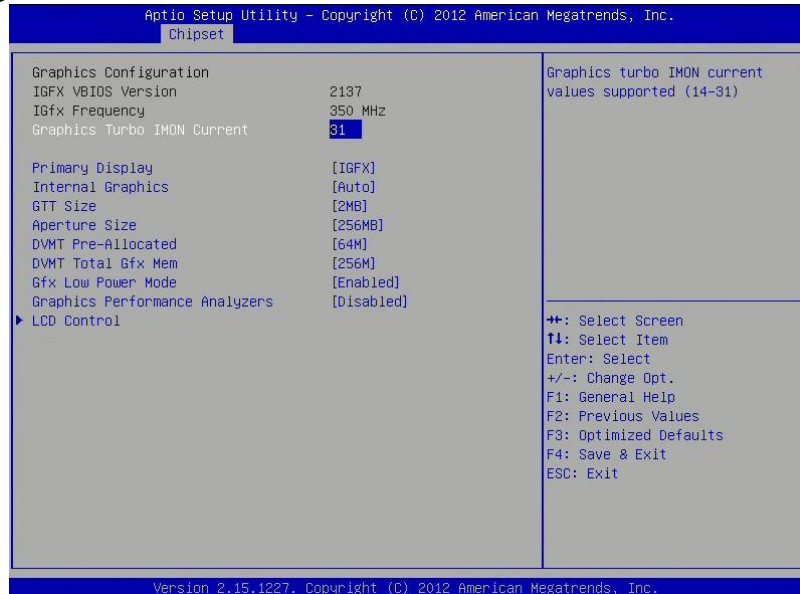

Primary Display

Select which of IGFX/PEG/PCI graphics device should be primary display or select SG for switchable Gfx.

Internal Graphics

Keep IGD enabled based on the setup options.

DVMT Pre-Allocated

Select DVMT 5.0 Pre-Allocated (Fixed) graphics memory size used by the internal graphics device.

DVMT Total Gfx Mem

Select DVMT 5.0 total graphics memory size used by the internal graphics device.

Gfx Low Power Mode

This option is applicable for SFF only.

Graphics Performance Analyzers

Enable or disable Intel graphics performance analyzers counters.

3.5.2.2 Memory Configuration

Aprio Setup Utility - Copyright (C) 2012 American Megatrends, Inc.

Chipset

<p>Memory Information</p> <p>Memory RC Version 1.6.0.0</p> <p>Memory Frequency 1333 Mhz</p> <p>Total Memory 2048 MB (DDR3)</p> <p>DIMM#0 2048 MB (DDR3)</p> <p>DIMM#1 Not Present</p> <p>CAS Latency (tCL) 9</p> <p>Minimum delay time</p> <p>CAS to RAS (tRCdmin) 9</p> <p>Row Precharge (tRPmin) 9</p> <p>Active to Precharge (tRASmin) 24</p> <p>XMP Profile 1 Not Supported</p> <p>XMP Profile 2 Not Supported</p> <p>DIMM profile [Default DIMM profile]</p> <p>Memory Frequency Limiter [Auto]</p> <p>Max TOLUD [Dynamic]</p> <p>NMode Support [Auto]</p> <p>Memory Scrambler [Enabled]</p> <p>MRC Fast Boot [Enabled]</p> <p>Force Cold Reset [Enabled]</p> <p>DIMM Exit Mode [Fast Exit]</p> <p>Power Down Mode [PPD]</p> <p>Scrambler Seed Generation Off [Disabled]</p>	<p>▲ Select DIMM timing profile that should be used.</p> <p>◆◆: Select Screen</p> <p>↑↓: Select Item</p> <p>Enter: Select</p> <p>+/-: Change Opt.</p> <p>F1: General Help</p> <p>F2: Previous Values</p> <p>F3: Optimized Defaults</p> <p>F4: Save & Exit</p> <p>ESC: Exit</p>
---	--

Version 2.15.1227. Copyright (C) 2012 American Megatrends, Inc.

Aprio Setup Utility - Copyright (C) 2012 American Megatrends, Inc.

Chipset

<p>Total Memory 2048 MB (DDR3)</p> <p>DIMM#0 2048 MB (DDR3)</p> <p>DIMM#1 Not Present</p> <p>CAS Latency (tCL) 9</p> <p>Minimum delay time</p> <p>CAS to RAS (tRCdmin) 9</p> <p>Row Precharge (tRPmin) 9</p> <p>Active to Precharge (tRASmin) 24</p> <p>XMP Profile 1 Not Supported</p> <p>XMP Profile 2 Not Supported</p> <p>DIMM profile [Default DIMM profile]</p> <p>Memory Frequency Limiter [Auto]</p> <p>Max TOLUD [Dynamic]</p> <p>NMode Support [Auto]</p> <p>Memory Scrambler [Enabled]</p> <p>MRC Fast Boot [Enabled]</p> <p>Force Cold Reset [Enabled]</p> <p>DIMM Exit Mode [Fast Exit]</p> <p>Power Down Mode [PPD]</p> <p>Scrambler Seed Generation Off [Disabled]</p> <p>Memory Remap [Enabled]</p> <p>Memory Alias Check [Disabled]</p> <p>Channel A DIMM Control [Enable Both DIMMS]</p> <p>Channel B DIMM Control [Enable Both DIMMS]</p>	<p>▲ Enable or disable dimms on Channel B.</p> <p>◆◆: Select Screen</p> <p>↑↓: Select Item</p> <p>Enter: Select</p> <p>+/-: Change Opt.</p> <p>F1: General Help</p> <p>F2: Previous Values</p> <p>F3: Optimized Defaults</p> <p>F4: Save & Exit</p> <p>ESC: Exit</p>
--	--

Version 2.15.1227. Copyright (C) 2012 American Megatrends, Inc.

3.6 Boot Setting

This section is used to configure the boot features.



Setup Prompt Timeout

Number of seconds to wait for setup activation key. 65535(0xFFFF) means indefinite waiting.

Bootup NumLock State

Select the keyboard NumLock state.

Quiet Boot

Enables or Disables Quiet Boot option.

Fast Boot

Enables or Disables boot with initialization of a minimal set of devices required to launch active boot option. Has no effect for BBS boot options.

GateA20 Active

UPON REQUEST – GA20 can be disabled using BIOS services.
 ALWAYS – do not allow disabling GA20; this option is useful when any RT code is executed above 1MB.

Option ROM Messages

Set display mode for Option ROM.

INT19 Trap Response

BIOS reaction on INT19 trapping by Option ROM: IMMEDIATE – execute the trap right away; POSTPONED – execute the trap during legacy boot.

Boot Option Priorities

Sets the system boot order.

3.7 Security

Use the Security Menu to establish system passwords

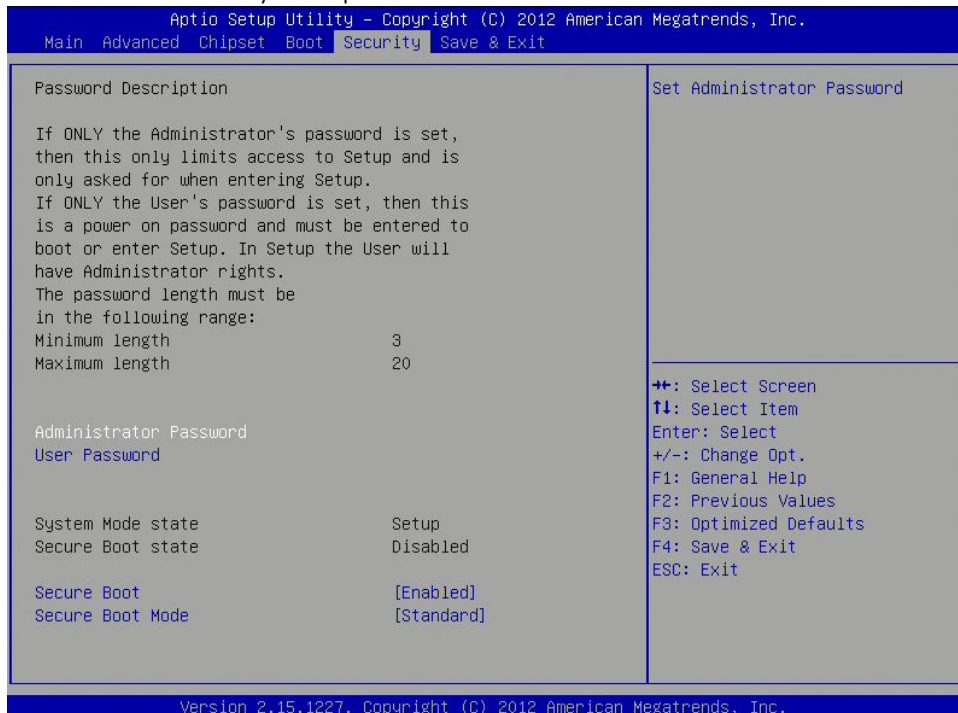

Administrator Password

Set administrator password.

User Password

Set User Password.

Secure Boot

Secure boot flow control. Secure boot is possible only if system runs in user mode.

Secure Boot Mode

Secure boot mode selector. 'Standard' – fixed secure boot policy, 'custom' – changeable image execution policy and secure boot key databases.

3.8 Save and exit

This screen provides functions for handling changes made to the BIOS settings and the exiting of the Setup program.

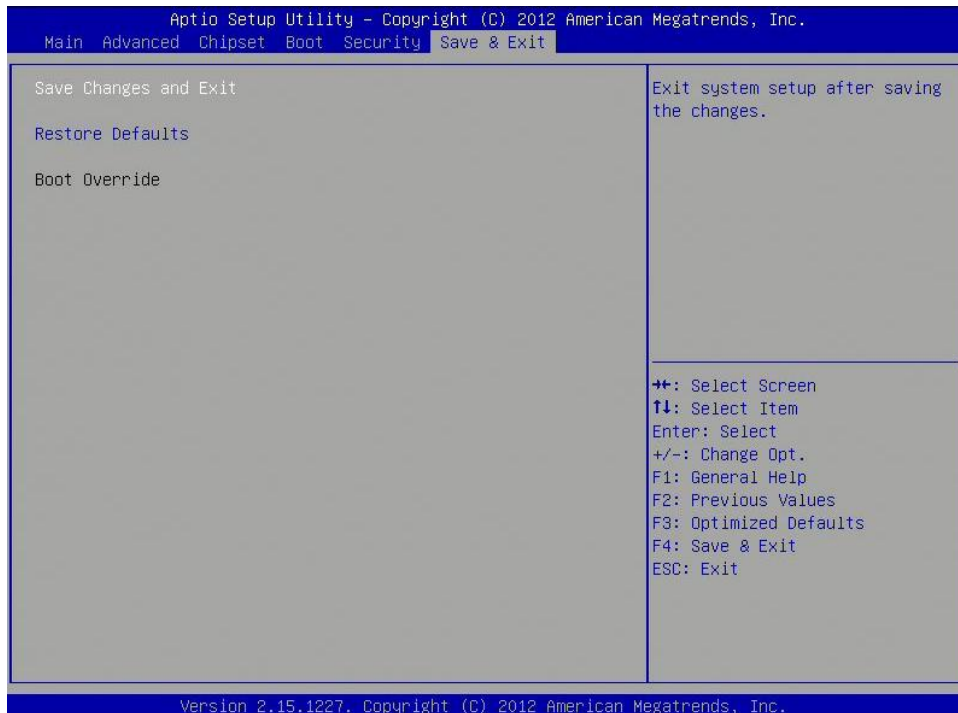

Save Changes and Exit

Exit system setup after saving the changes.

Restore Defaults

Restore or Load Defaults values for all the setup options.