

# SK220

PCIe/104(StackPC) MXM Carrier Module

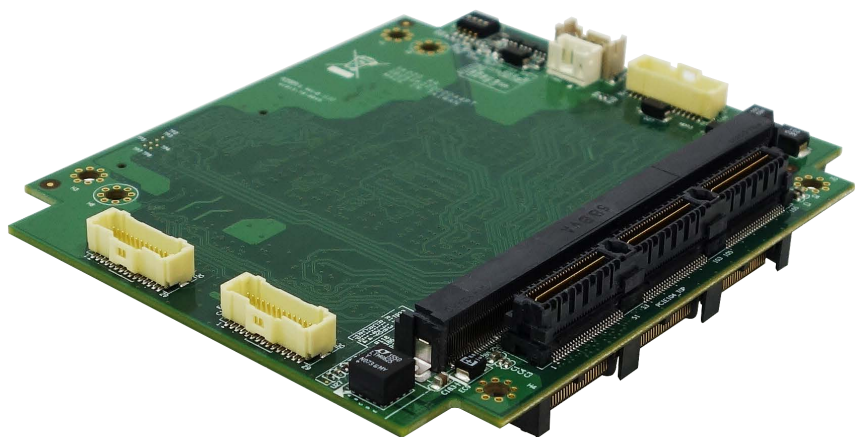

## Safety information

### Electrical safety

- To prevent electrical shock hazard, disconnect the power cable from the electrical outlet before relocating the system.
- When adding or removing devices to or from the system, ensure that the power cables for the devices are unplugged before the signal cables are connected. If possible, disconnect all power cables from the existing system before you add a device.
- Before connecting or removing signal cables from the motherboard, ensure that all power cables are unplugged.
- Seek professional assistance before using an adapter or extension cord. These devices could interrupt the grounding circuit.
- Make sure that your power supply is set to the correct voltage in your area.
- If you are not sure about the voltage of the electrical outlet you are using, contact your local power company.
- If the power supply is broken, do not try to fix it by yourself. Contact a qualified service technician or your local distributor.

### Operation safety

- Before installing the motherboard and adding devices on it, carefully read all the manuals that came with the package.
- Before using the product, make sure all cables are correctly connected and the power cables are not damaged. If you detect any damage, contact your dealer immediately.
- To avoid short circuits, keep paper clips, screws, and staples away from connectors, slots, sockets and circuitry.
- Avoid dust, humidity, and temperature extremes. Do not place the product in any area where it may become wet.
- Place the product on a stable surface.
- If you encounter any technical problems with the product, contact your local distributor

### Statement

- All rights reserved. No part of this publication may be reproduced in any form or by any means, without prior written permission from the publisher.
- All trademarks are the properties of the respective owners.
- All product specifications are subject to change without prior notice

## Revision History

Revision	Date (dd.mm.yyyy)	Changes
Version 0.9	23.03.2017	Draft
Version 1.0	14.06.2017	Initial Release

## Packing list

- SK220
- SK220-P
- Manual CD
- Screw Package



---

If any of the above items is damaged or missing, please contact your local distributor.

---

## Table of content

<b>SAFETY INFORMATION .....</b>	<b>1</b>
ELECTRICAL SAFETY .....	1
OPERATION SAFETY .....	1
<b>STATEMENT .....</b>	<b>1</b>
<b>REVISION HISTORY .....</b>	<b>2</b>
<b>PACKING LIST .....</b>	<b>2</b>
<b>TABLE OF CONTENT .....</b>	<b>3</b>
<b>CHAPTER 1: PRODUCT INFORMATION .....</b>	<b>4</b>
1.1 BLOCK DIAGRAM .....	4
1.2 KEY FEATURES.....	5
1.3 BOARD PLACEMENT .....	6
1.3.1 SK220 Top Side.....	6
1.3.2 SK220 Bottom Side.....	6
<b>CHAPTER 2: ONBOARD CONNECTOR AND SWITCH .....</b>	<b>7</b>
2.1 CONNECTOR .....	7
2.1.1 MVGA Connector .....	7
2.1.2 MDP1 Connector (DP1 & DP2).....	7
2.1.3 MDP2 Connector (DP3 & DP4).....	7
2.1.4 MDP3 Connector (DP5 & DP6).....	7
2.1.5 FAN1 .....	8
2.1.6 MXM_SEL.....	8
2.1.7 StackPC.....	9
2.1.8 FPE .....	11
2.2 SWITCH .....	13
2.2.1 SW1 .....	13

## Chapter 1: Product Information

### 1.1 Block Diagram

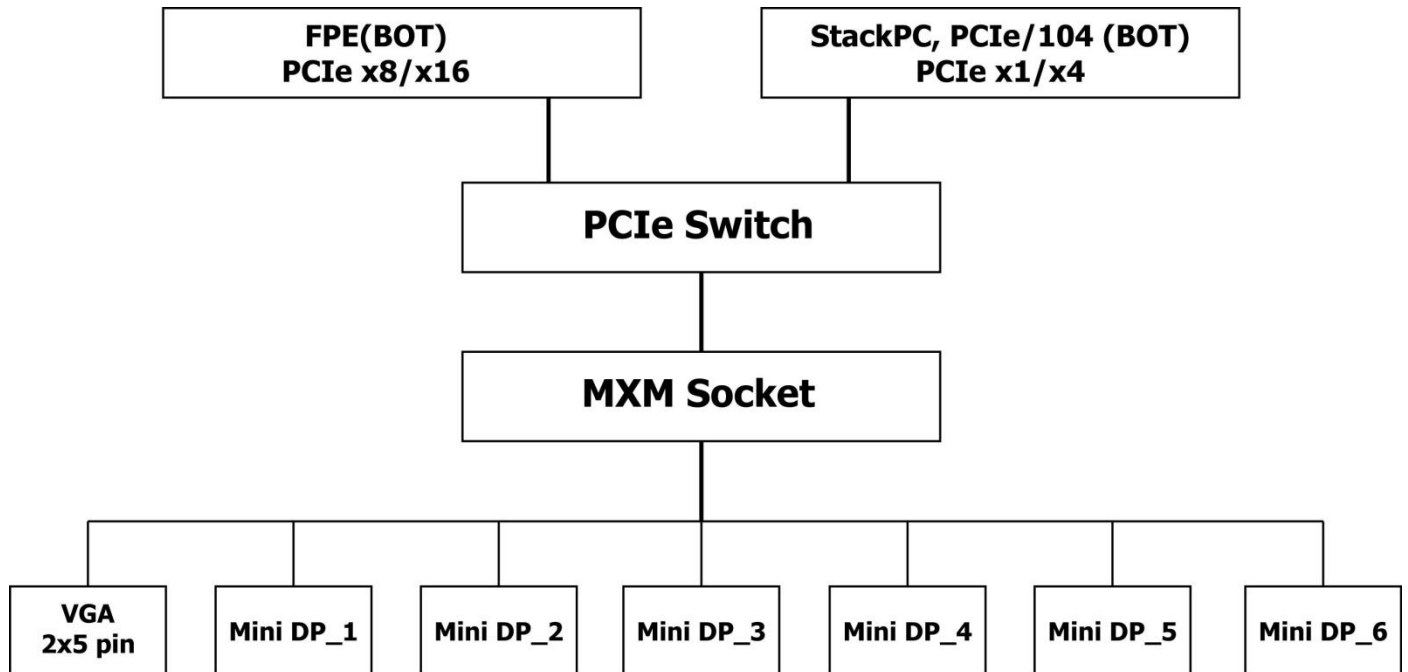

## 1.2 Key Features

Specification	
Function	PCIe104-FPE MXM Graphic Card Carrier
Signal Interface	PCIe Gen.3 x16/ x8/ x4/ x1
MXM version	Support MXM 3.0/3.1
Top Side I/O	PCIe104 Connector (Top) MXM Slot 1 x VGA (Pin Header) 6 x DisplayPort (Pin Header)
Bottom Side I/O	PCIe104 (Bottom) FPE (Bottom) <b>#Only on SK220</b>
Operating Temperature	Extended Temperature -40 to 85°C
Dimension	96 x 110 mm

### 1.3 Board Placement

#### 1.3.1 SK220 Top Side

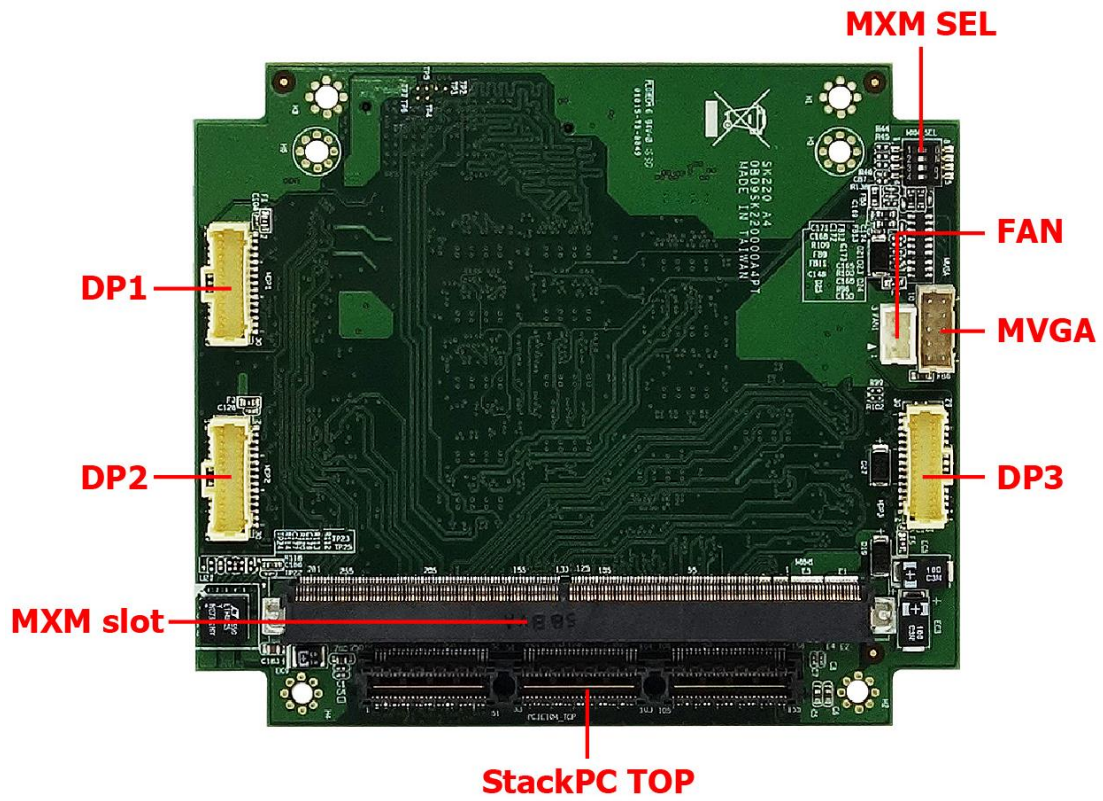

#### 1.3.2 SK220 Bottom Side

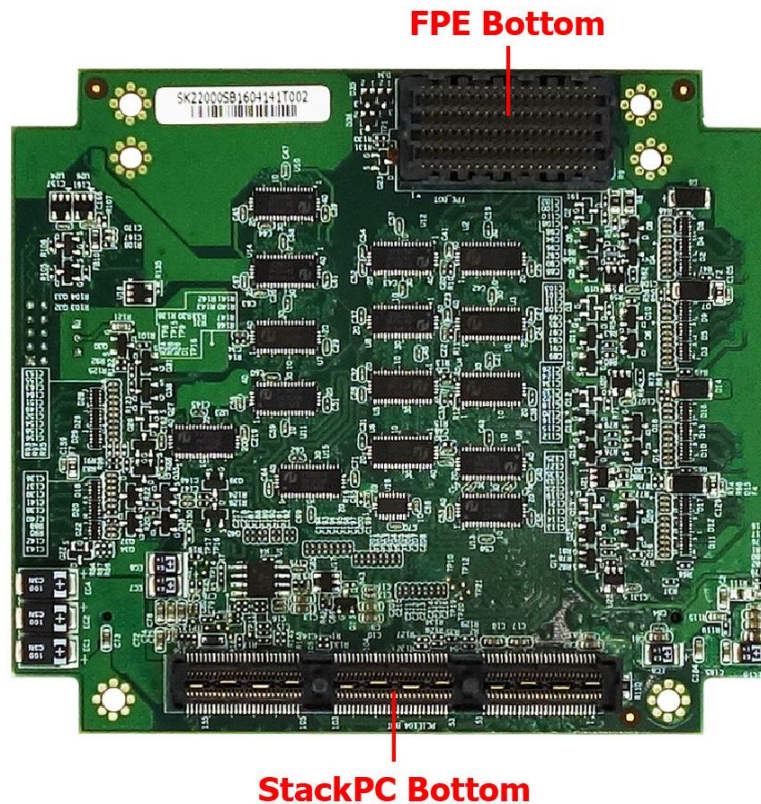



## Chapter 2: Onboard Connector and Switch

### 2.1 Connector

#### 2.1.1 MVGA Connector

2\*5P 180D P:2.0mm [E.I.C. 0110-02-163-100]

VGA			
Pin	Definition	Pin	Definition
1	RED	2	PWR
3	GREEN	4	GND
5	BLUE	6	GND
7	HSYNC	8	VSYNC
9	DDC_CLK	10	DDC_DAT

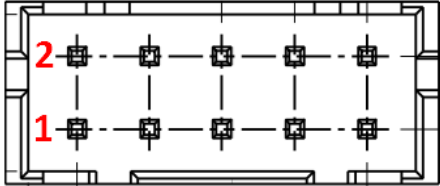

#### 2.1.2 MDP1 Connector (DP1 & DP2)

#### 2.1.3 MDP2 Connector (DP3 & DP4)

#### 2.1.4 MDP3 Connector (DP5 & DP6)

2\*15P 180D P:1.0mm [Molex 501190-3017]

DisplayPort			
Pin	Definition	Pin	Definition
1	DP1_AUXN	2	DP1_PWR
3	DP1_AUXP	4	DP1_TN2
5	DP1_TN3	6	DP1_TP2
7	DP1_TP3	8	DP1_TN1
9	GND	10	DP1_TP1
11	DP1_AUX_SEL	12	DP1_TN0
13	DP1_HPD	14	DP1_TP0
15	GND	16	GND
17	DP2_AUXN	18	DP2_PWR
19	DP2_AUXP	20	DP2_TN2
21	DP2_TN3	22	DP2_TP2
23	DP2_TP3	24	DP2_TN1
25	GND	26	DP2_TP1
27	DP2_AUX_SEL	28	DP2_TN0
29	DP2_HPD	30	DP2_TP0

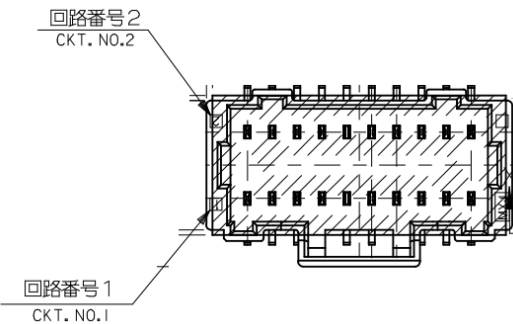



**2.1.5 FAN1**

FAN	
Pin	Definition
1	NC
2	+12V
3	GND

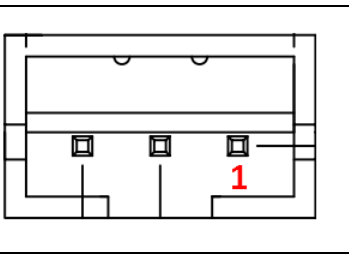

**2.1.6 MXM\_SEL**

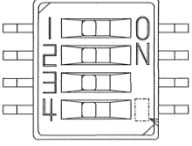
<b>MXM_SEL[1:3]</b>	<b>MXM PCIe Bus</b>	<b>CONN.</b>	<b>PCIE104_TOP</b>
	OFF-OFF-OFF	x16	FPE x1
	ON-OFF-OFF	x16	FPE x1 and x4
	OFF-OFF-ON	x8	FPE x1
	ON-OFF-ON	x8	FPE x1 and x4
	OFF-ON-ON	x4	PCIe/104 x1
	ON-ON-ON	x1	PCIe/104 x1 and x4

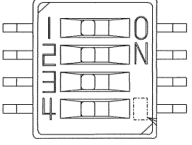
<b>MXM_SEL[4]</b>	<b>MXM Version</b>	
	OFF	v3.0
	ON	v3.1

**2.1.7 StackPC**

Bottom: Samtec [ASP-129646-03]

Top: Samtec [ASP-129637-03]

PIN	DEFINITION	PIN	DEFINITION	PIN	DEFINITION	PIN	DEFINITION
1	USB_OC#_4_5	2	RST_HEADER#	53	STK0_WAKE-	54	STK1_SATA_ACT-
3	+V3.3S	4	+V3.3S	55	-TYPE_DETECT	56	GND
5	USBD1+	6	USBD0+	57	LAN0_MDI0P	58	PCIEX4_TXP0
7	USBD1-	8	USBD0-	59	LAN0_MDI0P	60	PCIEX4_TXN0
9	GND	10	GND	61	GND	62	GND
11	PCIEX4_TXP1_1	12	PCIEX4_TXP0	63	LAN1_MDI1P	64	PCIEX4_TXP1
13	PCIEX4_TXN1_1	14	PCIEX4_TXN0	65	LAN1_MDI1N	66	PCIEX4_TXN1
15	GND	16	GND	67	GND	68	GND
17	PCIEX4_TXP1_2	18	PCIEX4_TXP1_3	69	LAN0_MDI1P	70	PCIEX4_TXP2
19	PCIEX4_TXN1_2	20	PCIEX4_TXN1_3	71	LAN0_MDI1N	72	PCIEX4_TXN2
21	GND	22	GND	73	GND	74	GND
23	PCIEX4_RXP1_1	24	PCIEX4_RXN0	75	LAN1_MDI1P	76	PCIEX4_TXP4
25	PCIEX4_RXN1_1	26	PCIEX4_RXP0	77	LAN1_MDI1N	78	PCIEX4_TXN4
27	GND	28	GND	79	LAN1_ALED	80	LAN0_LED_LNK#_ACT
29	PCIEX4_RXP1_2	30	PCIEX4_RXP1_3	81	SATATXP1	82	SATATXP0
31	PCIEX4_RXN1_2	32	PCIEX4_RXN1_3	83	SATATXN1	84	SATATXN0
33	GND	34	GND	85	GND	86	GND
35	CLK_PCIE_2P_1	36	CLK_PCIE_3P	87	USBD3+	88	USBD2+
37	CLK_PCIE_2N_1	38	CLK_PCIE_3N	89	USBD3-	90	USBD2-
39	+5VSB	40	+5VSB	91	GND	92	GND
41	CLK_PCIE_2P_2	42	CLK_PCIE_2P_3	93	USBD5+	94	USBD4+
43	CLK_PCIE_2N_2	44	CLK_PCIE_2N_3	95	USBD5-	96	USBD4-
45	GND	46	ATXPWOK	97	GND	98	GND
47	SMB_DATA	48	CLK_PCIE4_P	99	LAN1_CTREF	100	EHC_0_CTREF
49	SMB_CLK	50	CLK_PCIE4_N	101	SPI_MOSI	102	SPI_SS0
51	SMB_ALERT#	52	PS_ON#	103	SPI_MISO	104	SPI_SS1

PIN	DEFINITION	PIN	DEFINITION
105	ORTSSTK2_SPISCK	106	LPC_CLK
107	SPI_SS2	108	GND
109	LAN0_MDI2P	110	PCIEX4_RXP0
111	LAN0_MDI2N	112	PCIEX4_RXN0
113	GND	114	GND
115	LAN1_MDI2P	116	PCIEX4_RXP1
117	LAN1_MDI2N	118	PCIEX4_RXN1
119	GND	120	GND
121	LAN0_MDI3P	122	PCIEX4_RXP2
123	LAN0_MDI3N	124	PCIEX4_RXN2
125	GND	126	GND
127	LAN1_MDI3P	128	PCIEX4_RXP3
129	LAN1_MDI3N	130	PCIEX4_RXN3
131	PE_PRSNT1_A-	132	PE_PRSNT0_A
133	SATARXP1	134	SATARXP0
135	SATARXN1	136	SATARXN0
137	GND	138	GND
139	FBUS_1P	140	FBUS_P0
141	FBUS_1N	142	FBUS_N0
143	GND	144	GND
145	LPC_ADO	146	LPC_DRQ#
147	LPC_AD1	148	LPC_SERIRQ#
149	GND	150	GND
151	LPC_AD2	152	LPC_FRAME#
153	LPC_AD3	154	RTC_Battery
155	FBUS_1RTS-	156	FBUS_ORTS



**2.1.8 FPE**

Bottom: Samtec [SEAM-20-09.0-L-10-2-A-K-TR]

**(ONLY on SK220)**

PIN	DEFINITION	PIN	DEFINITION	PIN	DEFINITION	PIN	DEFINITION	PIN	DEFINITION	PIN	DEFINITION
1	DPC_HPD	2	DPC_AUX_P	3	NC	4	NC	5	NC	6	NC
11	GND	12	DPC_AUX_N	13	GND	14	NC	15	GND	16	NC
21	DPC_LANE1_P	22	+VDP_PWR	23	USB3_TX0P	24	GND	25	USB3_TX1P	26	GND
31	DPC_LANE1_N	32	DPC_LANE3_P	33	USB3_TX0N	34	USB3_RX0P	35	USB3_TX1N	36	USB3_RX1P
41	GND	42	DPC_LANE3_N	43	GND	44	USB3_RX0N	45	GND	46	USB3_RX1N
51	DPC_LANE0_P	52	GND	53	USB3_TX5P	54	GND	55	USB3_TX4P	56	GND
61	DPC_LANE0_N	62	DPC_LANE2_P	63	USB3_TX5N	64	USB3_RX5P	65	USB3_TX4N	66	USB3_RX4P
71	GND	72	DPC_LANE2_N	73	GND	74	USB3_RX5N	75	GND	76	USB3_RX4N
81	PEG_TXP0	82	GND	83	PEG_TXP2	84	GND	85	PEG_TXP4	86	GND
91	PEG_TXN0	92	PEG_TXP1	93	PEG_TXN2	94	PEG_TXP3	95	PEG_TXN4	96	PEG_TXP5
101	GND	102	PEG_TXN1	103	GND	104	PEG_TXN3	105	GND	106	PEG_TXN5
111	PEG_RXP_0	112	GND	113	PEG_RXP_2	114	GND	115	PEG_RXP_4	116	GND
121	PEG_RXN_0	122	PEG_RXP_1	123	PEG_RXN_2	124	PEG_RXP_3	125	PEG_RXN_4	126	PEG_RXP_5
131	GND	132	PEG_RXN_1	133	GND	134	PEG_RXN_3	135	GND	136	PEG_RXN_5
141	PEG_TXP8	142	GND	143	PEG_TXP10	144	GND	145	PEG_TXP12	146	GND
151	PEG_TXN8	152	PEG_TXP9	153	PEG_TXN10	154	PEG_TXP11	155	PEG_TXN12	156	PEG_TXP13
161	GND	162	PEG_TXN9	163	GND	164	PEG_TXN11	165	GND	166	PEG_TXN13
171	PEG_RXP_8	172	GND	173	PEG_RXP_10	174	GND	175	PEG_RXP_12	176	GND
181	PEG_RXN_8	182	PEG_RXP_9	183	PEG_RXN_10	184	PEG_RXP_11	185	PEG_RXN_12	186	PEG_RXP_13
191	GND	192	PEG_RXN_9	193	GND	194	PEG_RXN_11	195	GND	196	PEG_RXN_13

PIN	DEFINITION	PIN	DEFINITION	PIN	DEFINITION	PIN	DEFINITION
7	NC	8	NC	9	NC	10	NC
17	GND	18	NC	19	NC	20	NC
27	USB3_TX2P	28	GND	29	NC	30	NC
37	USB3_TX2N	38	USB3_RX2P	39	NC	40	NC
47	GND	48	USB3_RX2N	49	GND	50	NC
57	USB3_TX3P	58	GND	59	NC	60	NC
67	USB3_TX3N	68	USB3_RX3P	69	NC	70	NC
77	GND	78	USB3_RX3N	79	GND	80	NC
87	PEG_TXP6	88	GND	89	NC	90	NC
97	PEG_TXN6	98	PEG_TXP7	99	NC	100	NC
107	GND	108	PEG_TXN7	109	GND	110	PE_RST_FPE#
117	PEG_RXP_6	118	GND	119	PEx16_x8_x4_0Clkp	120	GND
127	PEG_RXN_6	128	PEG_RXP_7	129	PEx16_x8_x4_0Clkn	130	FPE_Bus_Err
137	GND	138	PEG_RXN_7	139	GND	140	Config_Type0
147	PEG_TXP14	148	GND	149	PEx16_x8_x4_1Clkp	150	Config_Type1
157	PEG_TXN14	158	PEG_TXP15	159	PEx16_x8_x4_1Clkn	160	Config_Type2
167	GND	168	PEG_TXN15	169	GND	170	NC
177	PEG_RXP_14	178	GND	179	NC	180	+V12S
187	PEG_RXN_14	188	PEG_RXP_15	189	NC	190	+V12S
197	GND	198	PEG_RXN_15	199	NC	200	+V12S

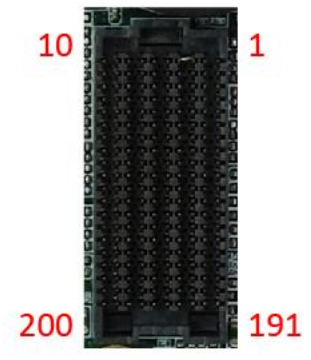

## 2.2 Switch

### 2.2.1 SW1

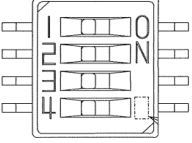
<b>MXM_SEL[1:3]</b>		<b>MXM PCIe Bus</b>	<b>CONN.</b>	<b>PCIE104_TOP</b>
	OFF-OFF-OFF	x16	FPE	x1
	ON-OFF-OFF	x16	FPE	x1 and x4
	OFF-OFF-ON	x8	FPE	x1
	ON-OFF-ON	x8	FPE	x1 and x4
	OFF-ON-ON	x4	PCIe/104	x1
	ON-ON-ON	x1	PCIe/104	x1 and x4

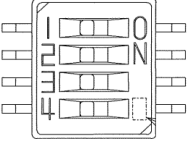
<b>MXM_SEL[4]</b>		<b>MXM Version</b>
	OFF	v3.0
	ON	v3.1